

优质稳定—打造最优秀的控制系统产品

Excellent Automation Systems Help U Win

UWNTEK
UWNTEK
UWNTEK
UWNTEK

UW500 Distributed Control System

System Manual

Table of Contents

Enterprise Introduction	1
Chapter 1 System Introduction	2
1.1 Outline.....	2
1.2 High Reliability.....	3
1.3 Powerful Functions	4
1.4 Open System.....	5
1.5 Easy Maintenance	5
Chapter 2 Network Structure	6
2.1 Outline	6
2.2 Management Net / MNet.....	7
2.3 System Net / SNet.....	8
2.4 Control Net / CNet	10
Chapter 3 Control Station	12
3.1 Outline	12
3.2 UW5101 Controller Module	13
3.3 UW5131 Modbus Communication Module	14
3.4 UW5132 Remote I/O Communication Module	17
3.5 UW5211 16 Channels HEART Analog Input Module	18
3.6 UW5212 16 Channels Large-Signal Analog Input Module.....	20
3.7 UW5213 16 Channels TC Analog Input Module	21
3.8 UW5214 16 Channels RTD Analog Input Module	22
3.9 UW5231 16 Channels Mixed Analog Input/Output Module.....	23
3.10 UW5311 32 Channels Digital Input Module.....	27
3.11 UW5322 16 Channels Digital Output Module	28
3.12 UW5341 32 Channels SOE Recorder Module.....	29
3.13 UW5411 System Power Supply Module.....	30
3.14 Cabinet and Accessories.....	31
Chapter 4 Operator/Engineering Station	32
Chapter 5 UWinTech Control Engineering Application Software Platform	33
5.1 Software Technical Characteristics	34
5.2 Software Functional Modules	36
5.3 System Engineering Flowchart	37
Appendix 1: Main Technical Parameters & Environmental Requirements	42
Appendix 2: Modules Size, Modules Address Setting & Installation in Cabinet	43
Appendix 3: UW500 DCS Form Selection Guidance	45
Chapter 6 Quality Control Management	51

Enterprise Introduction

National Engineering Research Center of Industrial Automation, Zhejiang University, established corresponding to national education subjects including Control Systems Engineering and Sensor Technology & Automation Equipments, is a comprehensively developing educational & researching organization, which functions as PhD station, post-PhD station, central national curriculums designer, State Key Laboratory as well as national engineering research center. NERC·IA's missions include: General-purpose large-scale industrial processes as technical background, develop key technologies which are significant to national economy, and form standardized, categorized and commercialized technology system & equipments series; Promote & spread technology to corporations and enterprises all over the country; Develop DCS system, Field-Bus, Automation Instrumentations & Apparatus; Develop application Software & Technologies for Advanced Control and Process Optimization, etc; Develop training simulator systems for all kinds of industries.

Under the leadership of outstanding scholars including Academician Sun You-Xian, PhD and Professor Wang Wen-hai, PhD, our research & development team long focus on researching and developing as well as Industrialization of Distributed Control System, Programmable Logic Controller, Intelligent Instrumentation, Software Platform for Control Engineering, Large-scale Equipment Automation System; We have undertaken 3 major specialized projects of Industrial Automation High Tech Industrialization assigned by National Development and Reform Commission, which indicates our firm knowledge accumulation and abundant technology experience; We have formed Complete Series of Computer Control Technology System & Products System with Independent Intellectual Property Rights, and accomplished 11 great innovation and technical breakthrough on core technologies, featuring Reliability Design Technology, Data I/O Technology, Real-time Control Technology, Real-time Database Technology, Software Platform Technology, etc. In the recent 5 years, in the field of Industrial Automation, acting as primary or secondary, we have achieved 1 National Technical Advancement first Prize, 1 National Technical Advancement 2nd Prize, 3 Provincial 1st Prize and 1 Provincial 2nd Prize. We have also achieved 20 software copyrights and 30 patents. Having concluded our decades' academic researching, knowledge accumulation and technical achievements, National Engineering Research Center of Industrial Automation, Zhejiang University has successfully developed its Next-Generation Control System ---- UW500 DCS System.

We, Hangzhou UWNTEK Automation System Co., Ltd, built up our Cooperation Technology Center in NERC.IA, Zhejiang Univ, have leading innovation concept and abundant technology resources. Our responsibility is industrialization, spreading and service of next-generation control technology. Our business and products involve researching and developing, manufacturing as well as marketing service of: Distributed Control System, Programmable Logic Controller, Intelligent Instrumentation, Software Platform for Control Engineering, Large-scale Equipment Automation System. We believe in values of "Practice, Innovation, Dedication and Profession"; We insist in concepts of "People as Foundation, Market as Guidance, Quality as Vitality, Reciprocation as Goal"; Experienced from technology innovation and market expanding, we have built up a cooperation team of Enterprise Management, Research & Development and Project Engineering Service which is reasonably constructed, experienced, united, diligent, enterprising and innovative. Over 50 percent of research & development stuffs possess master's degree or PhD.

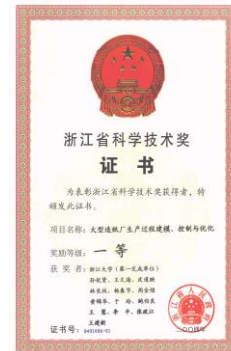
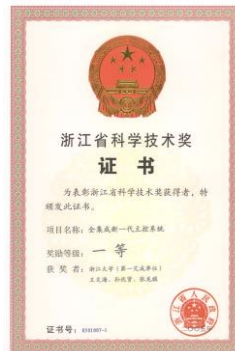

Chapter 1 System Introduction

1.1 Outline

Depending upon the comprehensive technical ascendancies of Zhejiang University, absorbing decades' academic and research state-of-the-art achievements of NERC-IA, State Key Laboratory of Industrial Control Technology and CSE, combining with our rich knowledge acquired in unremitting technology tackling and technical innovation as well as great experience in industrial application, after long-time and sustained application, improving, consummating and examining, we have successfully developed Excellent, Reliable, Advanced and Powerful Next-Generation Control System—UW500 (UWinPAS500) Distributed Control System, which is marked by its High Reliability, Open System, Powerful Functions and Easy Maintenance. More than 1000 sets of products already widely applied in all industrial fields, encompassing Petroleum Chemical, Thermal Power, Nuclear Power, Steel-making, Chemical Industry, Construction, Light Industry, Paper-making, Environmental Protection and so on.

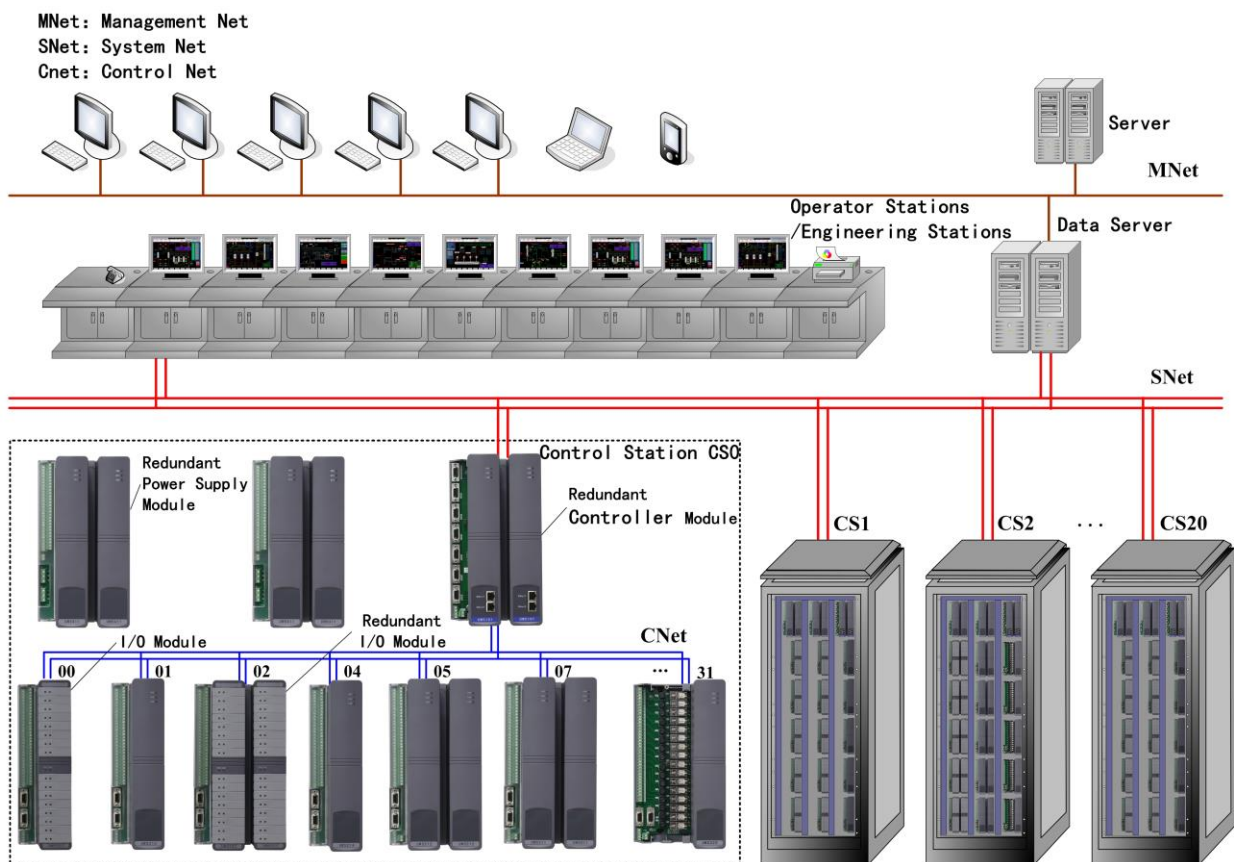

UW500 DCS System Framework



1.2 High Reliability

- **Hardware Redundancy Design:** Power Supply Module with high-availability (hot spare) redundancy design, supports dual electricity grid input; Control Net and System Net both applied dual high-available redundancy design; Controller Module dual redundancy with zero transition time, which ensures control consistency; System internal input voting algorithm, output voting algorithm, input/output self-diagnosis and error report mechanism for all digital and analog values, no user-programming necessity—redundancy design can simply be approached by configuring, and ensure efficiently and stably running.
- **High reliability I/O Modules** which are to-channel isolated, channel-to-channel inter-isolated, support to-channel Removal/Insertion under Power, meeting requirements of high reliability & security fields like nuclear power and emergency shutdown.
- **Parts Intellectualized Design:** I/O Modules, I/O Sub-Modules, Controller Module, Communication Modules all installed micro-controller-unites (MCUs) or multiple Processors, support Module self-diagnosis, fault-isolation, removal/insertion under power (RIUP) and on-process maintenance.
- **Intelligent conditioning,** supports universal analog signal (voltage/current/TC/RTD) input, software selects signal types, full-scale high accuracy, self-correction and no further calibration or maintenance necessity.
- **Electro-Magnetic Compatibility(EMC) Design:** All characteristics meet with related national standards as well as international standards: EN61000-4-2 (ESD) level 3, EN61000-4-3(RS) level 3, EN61000-4-4(EFT) level 3, EN61000-4-5(Surge) level 3, EN61000-4-6(CS) level 3 --- Excellent Immunity against interference.
- **Low-power-consumption design,** ventilation design based on natural circulation, thus no forced-cooling necessity and improves system adaptation to environment temperature.
- **Operation Safety Design:** Multi-user authority zone security mechanism; data off-line-holding, redundancy status checking, fast-recovery, information security guaranteed.
- **Strictly quality control & supervision on manufacturing process,** parts high-temperature preforming test for 72 hours, entire system comprehensively and continuously test for 120 hours; Obey ISO9001 International Standards through all working process, including system designing, developing, researching, manufacturing, service and so on.

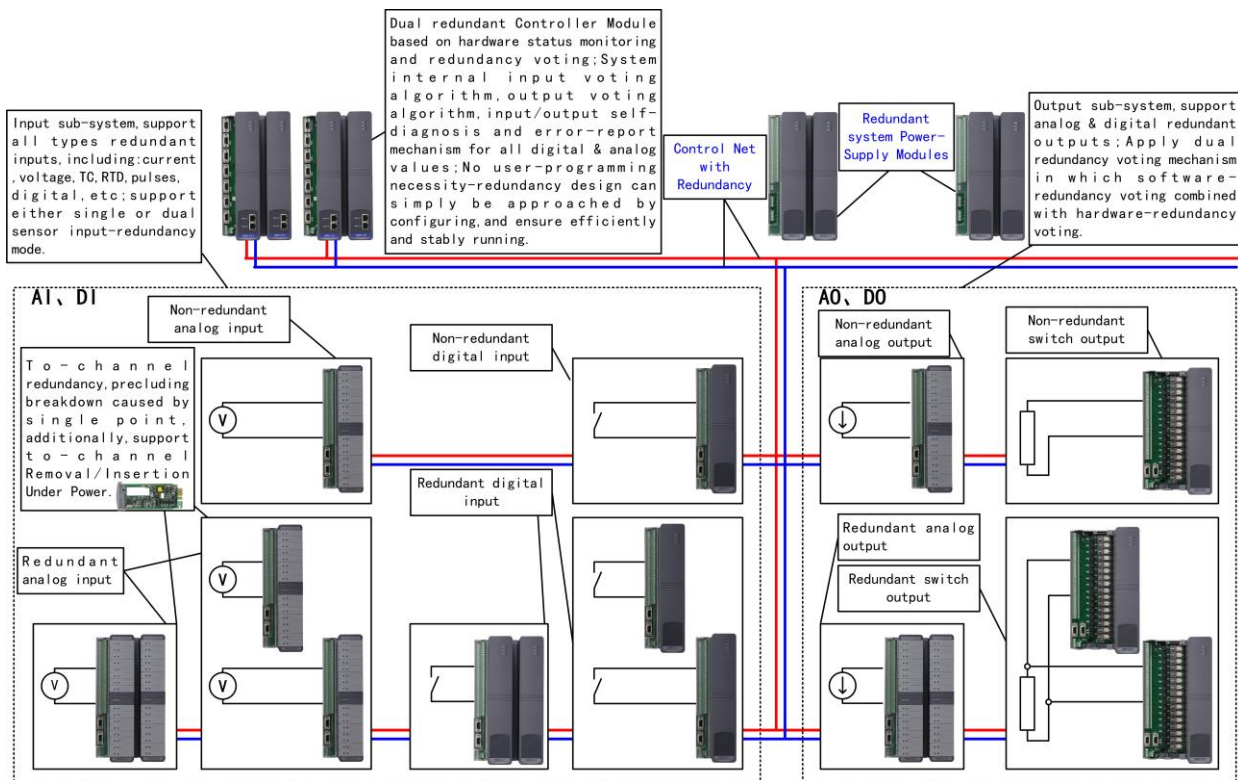

UW500 DCS Redundancy Structure

1.3 Powerful Functions

- Configurator Software realizes configuration and supervision of Controller Modules, I/O Modules and Control Net, System Net in all Control Stations of the control project. It also realizes self-diagnosis of Control Stations, Controller Modules, I/O Modules, CNet, SNet and convenient error-diagnosing & solving for running hardware devices, meanwhile record configuration events featuring I/O Modules configuration and on-line configuration, etc.
- Global Engineering Objects Real-time Database with maximum scale of 200,000 tags, supports off-line and on-line edit, delete, add, import/export, download, etc; All data tags support Alarm function and can be flexibly set according to user requirements, equipped with Alarm Control to real-timely supervise data abnormalities.
- Independently large History Database with maximum 200,000 tags, with minimum resolution time of 1 second and running load always less than 30%; Off-line and on-line edit, delete, add and save, while none of which influences the normal running or efficiency of History Database; History data visiting takes only several seconds and visiting efficiency would not be limited by the scale of History Database.
- Various expression forms of history data: dynamic simulation with tendency control, and timed counting, retrieving, saving in the form of reports, and even exporting to Relational Database for direct supervision.
- Supports control strategies off-line/on-line programming, off-line/on-line debugging and algorithm single step / single cycle debugging.
- Security Zone function covers all the stations in the entire system. According to safety & security conditions and requirements, it is possible to set Security Zones for real-time tags, graphic elements, functions, operation and supervision, and the running safety & security of the entire project is further improved.
- Global Events function provides operation records of the entire software platform including error information, user operation, etc. Then tracing afterwards would be easy, and the maintainability of the project is improved.
- Sequence of Events (SOE) recording function minimizes factory breakdown time, and provides powerful diagnosis tools for system supervision and accident analysis. Easy and convenient to configure, high-accuracy with millisecond-level resolution detecting process status & changes, real-timely recording and saving process events.
- Real-time Data Quality Stamps cover not only channels' absolute qualities such as channel abnormality, sampling bias, range overrun, network status, etc, but also process qualities including usage quality, storage quality and transmission quality, therefore ensure security of reference data.
- Remote Service function realizes remote visiting to project and real-time supervision to industrial fields through establishing Server Authorization & Client Access Mode.

通道序号	通道类型	通道名称	工作状态	报警级别	报警/输出上限	报警/输出下限
00	AI	电炉热电阻	新偶/断阻	-148.000	1218.189	3.781
01	AI	透热热电阻	新偶/断阻	2.781	1218.000	4.000
02	AI	F100热电阻	新偶/断阻	850.000	755.000	-5.000
03	AI	Cu50热电阻	新偶/断阻	-50.000	130.000	-30.000
04	AI	4~20 mA电流	正常	8.876	90.001	9.999
05	AI	0~100 mV电压	正常	9.543	90.001	9.999
06	AI	4~20 mA电流	正常	1.000	4.600	1.400
07	AI	4~20 mA电流	正常	4.000	18.400	5.600
08	AI	4~20 mA电流	正常	4.000	18.400	5.600
09	AI	4~20 mA电流	正常	4.000	18.400	5.600
10	AI	4~20 mA电流	正常	4.000	18.400	5.600
11	AI	0~100 mV电压	正常	8.713	90.001	9.999
12	AO	4~20 mA电流	正常	15.878	20.000	7.200
13	AO	4~20 mA电流	正常	18.090	20.000	7.200
14	AO	4~20 mA电流	正常	19.510	20.000	7.200
15	AO	0~10 mA电流	正常	10.000	10.000	0.000

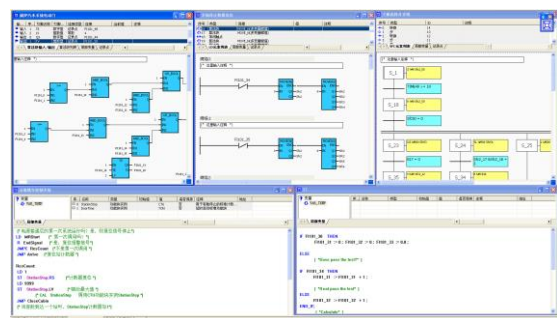

通道序号	通道名称	通道类型	通道地址	通道量程	通道精度	通道单位	通道描述
0000	W101_20	AI	0.00000	100.000	0.01	mA	电炉热电阻
0001	W101_20	AI	0.00000	100.000	0.01	mA	透热热电阻
0002	W101_20	AI	0.00000	100.000	0.01	mA	F100热电阻
0003	W101_20	AI	0.00000	100.000	0.01	mA	Cu50热电阻
0004	W101_20	AI	0.00000	100.000	0.01	mA	4~20 mA电流
0005	W101_20	AI	0.00000	100.000	0.01	mA	0~100 mV电压
0006	W101_20	AI	0.00000	100.000	0.01	mA	4~20 mA电流
0007	W101_20	AI	0.00000	100.000	0.01	mA	4~20 mA电流
0008	W101_20	AI	0.00000	100.000	0.01	mA	4~20 mA电流
0009	W101_20	AI	0.00000	100.000	0.01	mA	4~20 mA电流
0010	W101_20	AI	0.00000	100.000	0.01	mA	4~20 mA电流
0011	W101_20	AI	0.00000	100.000	0.01	mA	4~20 mA电流
0012	W101_20	AI	0.00000	100.000	0.01	mA	4~20 mA电流
0013	W101_20	AI	0.00000	100.000	0.01	mA	4~20 mA电流
0014	W101_20	AI	0.00000	100.000	0.01	mA	4~20 mA电流
0015	W101_20	AI	0.00000	100.000	0.01	mA	4~20 mA电流
0016	W101_20	AI	0.00000	100.000	0.01	mA	4~20 mA电流
0017	W101_20	AI	0.00000	100.000	0.01	mA	4~20 mA电流
0018	W101_20	AI	0.00000	100.000	0.01	mA	4~20 mA电流
0019	W101_20	AI	0.00000	100.000	0.01	mA	4~20 mA电流
0020	W101_20	AI	0.00000	100.000	0.01	mA	4~20 mA电流
0021	W101_20	AI	0.00000	100.000	0.01	mA	4~20 mA电流
0022	W101_20	AI	0.00000	100.000	0.01	mA	4~20 mA电流
0023	W101_20	AI	0.00000	100.000	0.01	mA	4~20 mA电流
0024	W101_20	AI	0.00000	100.000	0.01	mA	4~20 mA电流
0025	W101_20	AI	0.00000	100.000	0.01	mA	4~20 mA电流

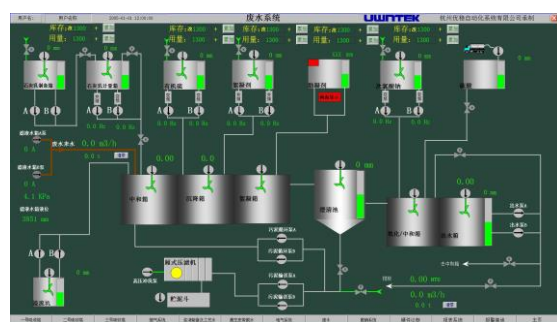

1.4 Open System

- Supports 5 arithmetical programming language with different styles: FBD (functional blocks diagram) / LD (ladder diagram) /SFC (sequence function chart) / ST (structured text) / IL (instruction list); More than its standardized, flexible and derivable characteristics, also realizes concepts of algorithm mixed programming, sub-program module, algorithm-graphics binding, on-line programming & simulation and step-by-step off-line/on-line debugging, as well as provided interface supporting third-party algorithm importing.
- Open system structure, comprehensively supports DDE, OPC, ODBC/SQL, OLE DB XML, ActiveX standards, etc; Provides external access interface in various terms of OLE, COM/DCOM, API, etc, which makes user's deeper re-development with common develop tools (VC++, VB, .net, etc) more convenient and easier to joint with third-party software;
- "Inclusive & Incorporative" Real-time Database, under a real-time and open structure, enhances support to kinds of third-party protocols, covers almost all the popular communication protocols in the market, and is quite ready to add new device drivers for special applications; Third-party devices and UW series control system hardware are based on standardized & unified device description models, and can be interconnected perfectly in running process; To conclude, all of which listed above constructed a clean & clear system conceptual and a secure & compact system structure, truly improved running stability and security, and allowed system's easy diversification & expanding.
- Consistently applying the traditional "Graphics Multiplexing" mode to generate kinds of industry process graphics, further applied "Expand Elements Library" concept ---- named as "Expand" because the "Elements Library" is open to import in to library "Elements" provided by the third-parties as well as new elements combinations made by the user. Significantly reduced graphics making workload, and also makes the system friendly, easy-to-use, flexible and open.
- Modular & Scalable Structure, Open Software Platform, Professional Application Software, Flexible Integration according to industry requirements, realizes Horizontal and Vertical Expanding, extraordinarily applicable to all kinds of industries, featuring: small-scale equipments control system like Chemical Industry, Pharmacy, Construction, Light Industry, Urban Engineering, middle-scale equipments & combined-equipments control system like Electricity, Petroleum, Metallurgy, and even core-equipments high-reliability & safety control system like Nuclear Power, Petroleum Chemistry, High-speed Railway.

1.5 Easy Maintenance

- I/O Modules equipped with industrial wiring Terminal Chassis, cancelled accessories such as system rack, bottom support, terminal blocks and wiring cables, significantly reduced hidden reliability dangers caused by wiring; Supports installation on both sides of control cabinet, integrated control cabinet and terminals cabinet, all of which lead to easier maintenance, less space occupation and lower costs.
- Supports Modules / Sub-Modules / Network Self-Diagnosis, Modules Removal/Insertion Under Power (RIUP) possible, on-process repairing possible, which makes maintenance easier.
- Intelligent & multi-functionalized Modules, less module types, easier repairing, eliminate configuration wastes, reduce spare parts;
- Analog signal type selection and Digital input/output mode switching can be easily achieved by software setting. Convenient Signal Type Selection & easy Modification;
- We provide Remote Technical Support and timely System Guidance, Training and Maintenance Service.



Chapter 2 Network Structure

2.1 Outline

UW500 Distributed Control System applied a Triple-layers Network Structure consists of Management Net / MNet, System Net / SNet and Control Net / CNet, respectively. CNet interconnects the functional Modules; SNet is Industrial Ethernet and is able to interconnect multiple Control Stations or Operator Stations / Engineering Stations; Operator Stations / Engineering Stations can be connected with MIS (Management Information System) or ERP (Enterprise Resource Plan) through MNet.

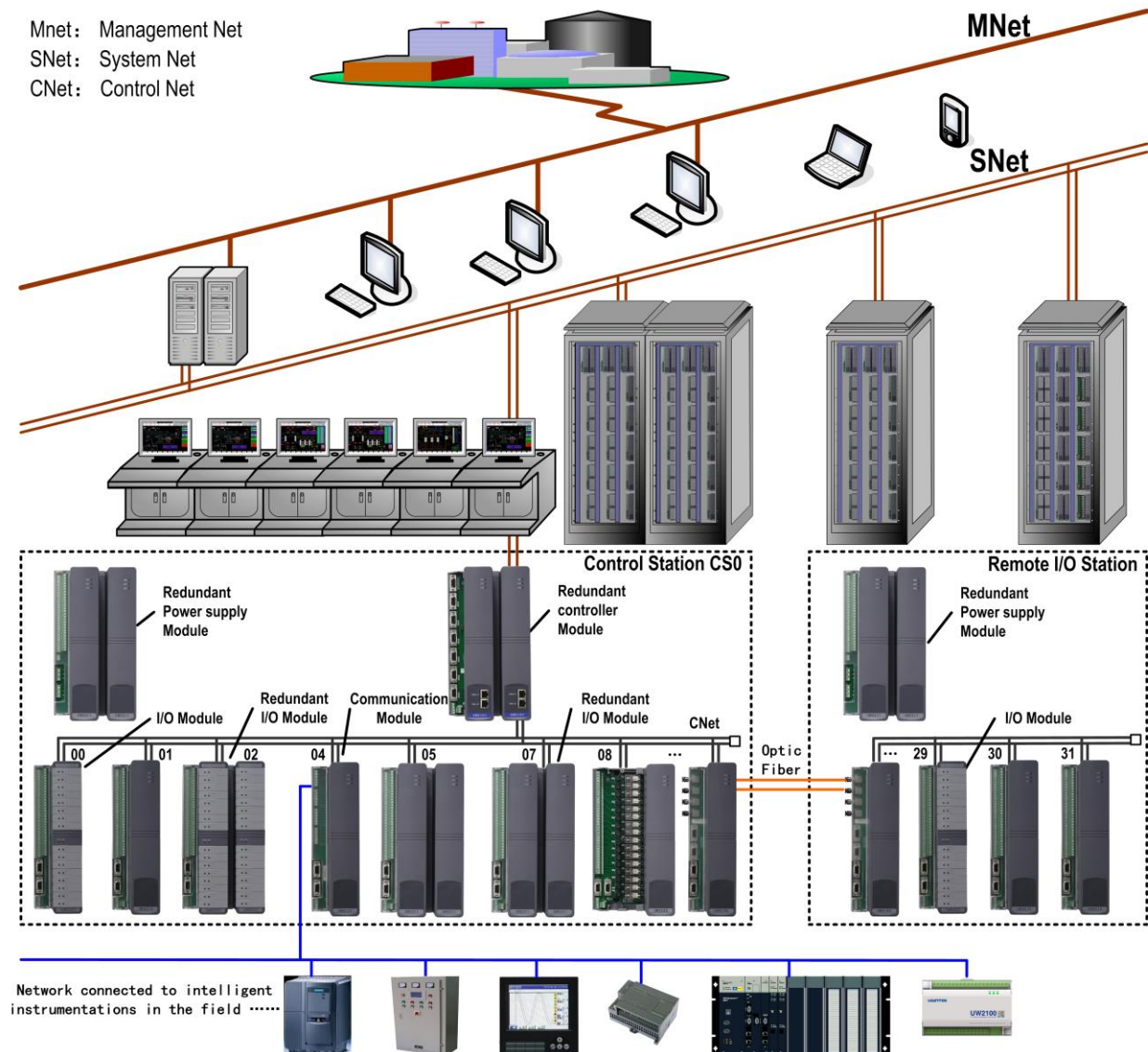

UW500 DCS Network Structure

Control Net realizes: coordination control and communication between different units, equipments or workshops; management data communication of multiple equipments groups or manufacturing processes; coordination control and scheduling between sub-systems in large industrial process.

System Net of UW500 DCS system is a real-time industrial network, it connects system nodes including Engineering Stations, Operator Stations and Field Control Stations. SNet realizes data communication of and between Operator Stations and Field Control Stations, as well as ensures data consistency. SNet applied Industrial Ethernet and complies with IEEE802.3 standard; SNet applies reliable High-Available (Hot Spare) redundancy structure, and ensures breakdown of any single network would not influence system communication. The maximum communication distance of System Net is related to the number of Hubs/Optical Transceivers and communication medium ---- maximum length of twisted pair is 120m, while max length of Optic Fiber is 1850m. Hardware of System Net involves Operator/Engineering Station, Control Station, Hubs/Optical Transceivers as well as their communication medium, and the maximum number of nodes in a SNet is set to be 64, which consists of 32 Operator/Engineer Stations and 32 Field Control Stations.

Control Net is the real-time redundant network internal of a Control Station. It realizes interconnection and information communication between I/O Modules and Controller Modules inside of the CS. The maximum nodes number in a CNet is 64.

These Nets are responsible in many tasks including: transmitting process variables, control commands, configuration information, alarm information and history data, etc. Network performance, say, structure, hierarchy, flexibility, openness, transmission method, significantly determines the performance of the entire system.

2.2 Management Net / MNet

MNet applies Ethernet and realizes enterprise/factory-level information communication & management. Acts as the information channel of the entire enterprise/factory, its functions are listed below:

- Access system process parameters and running information from Operator Stations (or special servers), meanwhile send scheduling commands and manufacturing instruction information from upper management computers to lower level;
- Management data communication between multiple equipments groups or manufacturing process in the enterprise;
- Coordination control and scheduling management between sub-systems of large-scale industrial process.
- Enterprise/factory-level integrated management, scheduling, statistics and decision making, etc.

Main Technical Parameters of MNet

<i>Network</i>	Ethernet
<i>Topology Structure</i>	Tree, Star, etc.
<i>Communication Medium</i>	Twisted Pairs, Optic Fiber, Coaxial Cable
<i>Redundancy</i>	Optional
<i>Baud Rate</i>	10M/100M/1000Mbps
<i>Network Protocol</i>	TCP/IP, NETBEUI, etc.
<i>Capacity</i>	Maximum 1024 nodes
<i>Communication Distance</i>	Maximum 10km (related to transmission medium)

2.3 System Net / SNet

2.3.1 SNet Summary

SNet is dual-redundant, real-time high-speed Industrial Ethernet. It directly connects Field Control Stations, Operator Stations, Engineering Stations and data communication modules. SNet is the channel transmitting real-time information of control process, and is highly real-time and reliable. SNet is able to access to third-party control systems or intellectual instrumentations through data communication modules connected to it; It can also to send control process information to upper information management network through Operator Stations that are installed with data service software, or through dedicated servers. Main functions of SNet are:

- Enables Field Control Stations to send the collected I/O data to Operator Stations;
- Data communication between Field Control Stations ---- fulfills the requirements of large-scale coordination control;
- Enables Operator Stations and Engineering Stations to send control commands or configuration data to Field CS;
- Synchronization, keeps data consistency between Operator Stations;

2.3.2 SNet Performance & Characteristics

The communication medium, exchangers and adaptors of SNet all configured Dual-Redundancy ---- we call the redundant nets Net A and Net B, respectively. Stations transmit data synchronously through both nets, and receiver stations select and receive the redundant data packets according to the received packets' time marks & quality marks. In this way risks of transmission failure caused by a single net is avoided, and almost no recovery time is needed when the error net recovers.

Real-time communication of SNet is totally based on UDP/TP protocol. UDP is a most simple and no-connection transmission protocol. In communication process, UDP not only reduced huge connection structuring & destructing costs, but also significantly improved communication speed as there is no data-conformation or repeat necessity.

Based on UDP protocol, in SNet we comprehensively applied Multicast and Broadcast technologies, and thus significantly relieved network communication burden. For data communication, SNet of UW500 DCS further provides functions including flow control, error control, ARQ (automatic repeat request), transmission message SOE check, transmission message quality marks check, etc, all of which ensure data reliability. Therefore System Net of UW500 DCS has fully ensured process information efficient, real-time and reliable transmission, and precluded Industrial Ethernet-based SNet's breakdown caused by communication overload.

Main Technical Parameters of SNet

<i>Network</i>	Industrial Ethernet
<i>Topology Structure</i>	Bus or Star
<i>Communication Medium</i>	Twisted Pairs, Optic Fiber, Coaxial Cable (thin)
<i>Redundancy</i>	Single or Dual
<i>Baud Rate</i>	10Mbps/1000Mbps
<i>Network Protocol</i>	IEEE802.3 standard protocol, UDP/IP,TCP/IP protocol
<i>Capacity</i>	Max 64 Field CS or data communication modules; Max 64 OS/ES
<i>Communication Distance</i>	Maximum 10km (related to transmission medium)

2.3.3 SNet Equipments

SNet hardware involves Engineering Station, Operator Stations, Field Control Stations, Communication Modules, Ethernet exchanger / Optic transceivers, communication medium and so on.

2.3.3.1 Communication Medium & Device

According to system scale, spatial distribution and communication volume, select suitable communication medium and network connection mode:

<i>System Scale</i>	<i>Communication Medium & Device</i>
$0m \leq \text{communication distance} \leq 100m$	Twisted pairs / Exchanger
$100m \leq \text{communication distance}$	For $\leq 100m$ part, use Twisted pairs / Exchanger; For $\geq 100m$ part, use Optic Fiber / Optic Transceiver

2.3.3.2 Network Adapter for Operator/Engineering Stations and Communication Modules

SNet Network Adapter for Operator/Engineering Stations and Communication Modules is Ethernet card. For redundant SNet, there need to install two Ethernet cards. If O/E Stations are to be connected with Management Net, there need to install another Ethernet card.

2.3.3.3 Network Adapter for Field Control Station

A Controller Module of Field CS integrates two SNet controllers and two CNet controllers, and internally installed 7 or 8-channel CNet Hub or exchanger for I/O Modules connection.

2.3.4 SNet IP Address Setting

System Net is connected with nodes including Field Control Stations (Controller Modules), Operator Stations, Engineering Station, etc. IP setting principles of those network devices:

<i>Type</i>	<i>IP range</i>			<i>Description</i>
	<i>Network</i>	<i>Network Segment</i>	<i>Station Address</i>	
Control Station	Net A	192.192.1	2~64	Set network address through DIP switch on the terminal chassis of Controller Modules.
	Net B	192.192.2	2~64	
Operator/Engineering Station	Net A	192.192.1	129~192	Set IP address in operation system.
	Net B	192.192.2	129~192	

For O/E Stations, just set corresponding IP address in operation system. The IP address 192.192.1.1 and 192.192.2.1 specifically used for GPS clock generator, While for Controller Modules, set network address through DIP switch on the Terminal Chassis of Controller Modules: the flags 6 bits(S0~S5) are for setting Controller Module address, they make up a stations address range from 2 to 64.

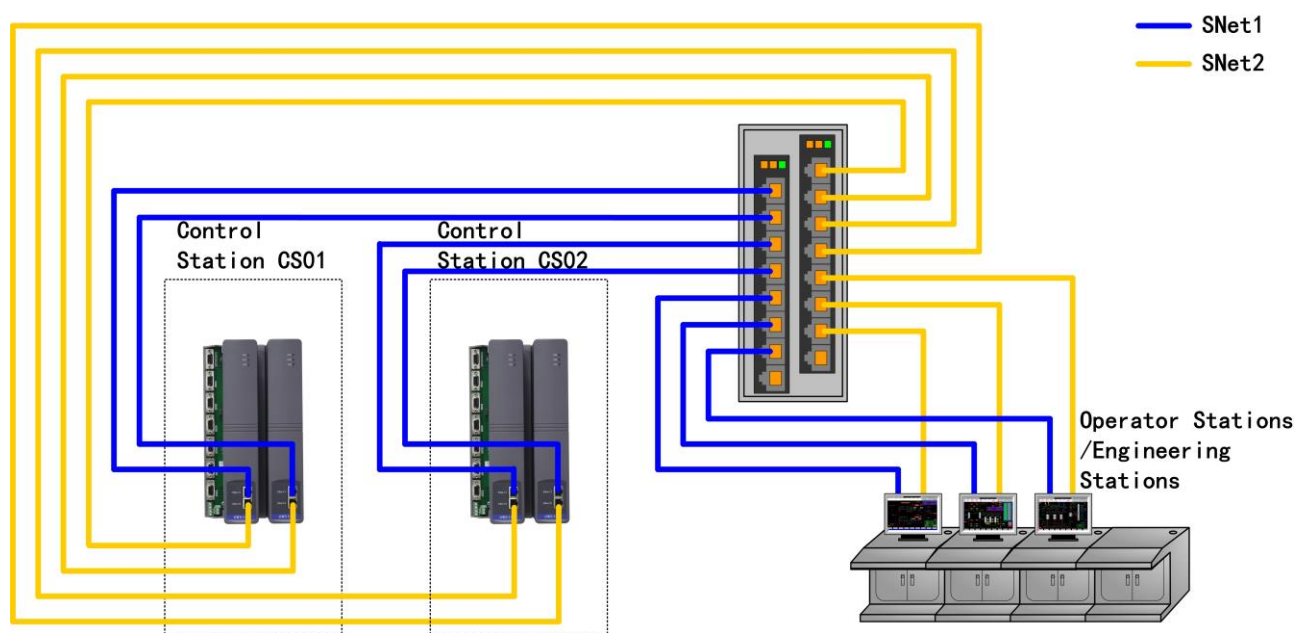

SNet Network Connection Diagram (CS*2, OS/ES*3)

2.4 Control Net / CNet

2.4.1 CNet Summary

Control Net is the real-time redundant network internal of a Control Station. It realizes interconnection and information communication between I/O Modules and Controller Modules inside of the CS. Physically, CNet lies between I/O Modules which are under the management of the Field Control Station.

2.4.2 CNet Performance & Characteristics

CNet applies CAN (Control Area Network) and complies with ISO11898 CAN Specification 2.0B standard. It is a Priority-Preemptive bus-network, functions as:

- Multi-primary working mode, any node (Module) in the network could actively transmit data to other nodes at anytime, while without primary/secondary distinction; Flexible communication mode which does not request nodes IP information, thus builds up multi-device backup system easily;
- Network nodes information are ranked in different priorities, fulfilling different real-time requirements. Data with high priority rank could be transmitted within no larger than 134us;
- Applies Non-destructive Bus Arbitration technology: in the case that multiple nodes synchronously transmit information to the bus, nodes with lower priorities would quit transmission while nodes with higher priorities may continue normal transmission, thus bus conflicts-arbitration duration is significantly reduced. Network breakdown is avoided even in the case of serious network overload;
- Data transmission/receiving is easily achieved through several modes featuring node-to-node, node-to-multi-nodes and global broadcast, no intentional "scheduling" necessity;
- Maximum nodes number is mainly determined by bus-driver circuit, so far this number is 110. Message identifiers maximum 2032 for CANBUS2.0A, and almost unlimited for CANBUS2.0B (expanded standard);

- Short-frame data structure, short transmission time, high immunity, extraordinary error-detection capacity;
- CRC (cyclic redundancy check) and other error-detection for every frame of information, data error possibility is extremely low;
- Nodes automatically stop transmitting when serious problems happen, so other nodes in the bus would not be influenced;
- Communication medium could be flexibly selected either Twisted Pair, or Coaxial Cable, or Optic Fiber.

Main Technical Parameters of CNet

<i>Network</i>	CAN(Control Area Network)-Bus 2.0B
<i>Topology Structure</i>	Bus
<i>Communication Medium</i>	Twisted Pairs
<i>Redundancy</i>	Single or Dual
<i>Baud Rate</i>	1Mbps
<i>Network Protocol</i>	CAN-Bus expanded protocol
<i>Capacity</i>	Max 7 Controller Modules; Max 32 I/O Modules
<i>Communication Distance</i>	Twisted Pairs: Max 34m; Can be expanded to 2km by applying a pair of UW5132 Remote I/O Modules and Optic Fiber

2.4.3 CNet IP Address Setting

CNet IP address of an I/O Module is set on DIP switch in the middle of Module's Terminal Chassis. Address ranges from 0 to 31, set on lower 5 bits(S4~S0, while S5 is expanding reserve bit and must be set 0); For a pair of redundant Modules, only need to set address once on Terminal Chassis, and the address of next module will automatically plus 1.

For Modules IP address setting, see Appendix 2: Modules Size, Modules Address Setting & Installation in Cabinet.

Chapter 3 Control Station

3.1 Outline

Control Station hardware of UW500 Distributed Control System includes Controller Module, Communication Modules, Power Supply Module, I/O Modules, Cabinet & Accessories; Maximum scale of one single Control Station: Analog Input/Output: 512, or Digital Input 1024, or Digital Output 512; A system can support 21 Control Stations, thus maximum scale of one single system: AI/AO/DO: 10752 or DI: 21504.



UW500 Distributed Control System Control Stations

Functional Modules that accomplishes certain tasks inside of the Control Stations are combinations of hardware boards, control & processing units and application software. Each Functional Module is intellectualized, individual and independent, and accomplishes its own tasks timely and efficiently. Functional Modules are interconnected through redundant Control Net.

- Controller Module: Integrated high-speed processor, redundant CNet and redundant SNet, explains & executes designed control strategies, and supports data synchronization and primary-redundancy switching.
- Analog Input Modules: support signal type selection, programmable amplification, data conversion, error detection, digital filtering, temperature compensation, linearity correction, industrial transforming, etc. Support universal inputs.
- Analog Output Module: Realizes analog data calibration, latch & output protection. According to configuration, can realize output data holding or output set value in abnormal conditions.
- Analog Mixed Input/output Module: Realizes mixed AI/AO, supports to-channel isolation, to-channel power supply, to-channel Removal/Insertion Under Power.
- Digital Input Module: Realizes Digital Input, filtering DI jitter, generating varying time stamps, real-time response.
- Digital Output Module: Realizes Digital Output, digital output calibration, diagnosis, power-off memory-holding, power-on protection, etc.

3.2 UW5101 Controller Module









As the operation processing center of Control Station, UW5101 Control Module UW5101 is the core part of Control Station; From the hardware aspect, it consists of a series of functional units including embedded industrial CPU, real-time data register, redundant SNet driver and redundant CNet driver, etc; From the software aspect, UW5101 is responsible in coordinating all the functional modules' data communication, control processing in the Control Station, such as I/O signals processing, control loops arithmetic operation, network communication processing, redundancy diagnosis & switching, etc. With powerful data processing capacity and standardized industrial-rank hardware quality, ensures high-speed & reliable realization of all kinds of control strategies in industrial fields.

Functional Characteristics:

- Embedded MCU of military rank quality, main frequency 720MHz, 256MB Database area, providing powerful and stable data calculation and processing platform;
- Integrated dual-channels CNet controller and driver interface, dual-redundancy configuration which ensures good functioning of Control Net;
- Integrated dual-channels 100Mbps SNet controller and driver interface, dual-redundancy configuration which ensures good functioning of System Net;
- Realizes complex programmable logic using CPLD, peripheral high-speed accessing and non-accessing protection, ensuring convenient and reliably access.
- Non-volatile Ferroelectric RAM/FeRAM technology ensures real-time database does not lost when power-off, thus no reserve battery necessity and system security and maintainability enhanced;
- Real-time Multi-task operational system, modularly designed control programs & algorithms, all core programs solidified;
- Abundant self-diagnosis and running status information indicator available on Module panel;
- Can be connected with maximum 32 I/O Modules through CNet, in other words 512 AIO channels or 1024 DIO channels under process;
- Control strategies support on-line programming, on-line debugging and power-off protection.



Technical Parameters

Item	Parameter	
MCU	Embedded 32bit CPU, 720MHz	 SOE_CLK_INPUT
Memory	256M DDR2 SDRAM	 CNET
Data Storage	256MB NANDFLASH	 CNET
Data Power-off Holding	128K FeRAM	 CNET
Processing Capacity	2048 Control Loops / s	 CNET
Scanning Period	Digital≥25ms, Analog≥50ms	 CNET
CNet Interface	×2, Baud Rate 1Mbps	 CNET
SNet Interface	×2, Baud Rate 100Mbps	 CNET
Module Size	266mm×146mm×157mm	
Power Consumption	2.5W	
Working Temperature	-20°C~60°C	
Terminal Chassis	UW5172 Specialized Terminal Chassis for Controller Modules with Dual-Redundancy.	

3.3 UW5131 Modbus Communication Module

UW5131 Modbus Communication Module provides 4-channels isolated RS-485 communication interface, supports ModBusRTU master protocol, realizes 4 independent groups or 2 pairs of 1:1 redundant groups third-party intellectual instrumentations' (which are capable in Modbus communication) direct data importing to UW500 Field Control Station; Supports Modbus RTU slave protocol, any TS-485 interface can link the Modbus master protocol, by setting the communication parameters in operation software to complete the communication; From the hardware aspect, UW5131 consists of embedded industrial processor, real-time data register, redundant CNet and driver, 4-channels serial communication controller and 4-channels isolated RS-485 communication interface; From the software aspect, it is responsible in communication scheduling, network diagnosis, network recovery and register map management with third-party intellectual instrumentations, as well as data synchronization, device management, real-time database connection map with Controller Module through redundant Control Net .



Functional Characteristics:

- Embedded MCU of industrial rank quality, provide powerful and stable Modbus communication control & management;
- Integrated Dual-redundant 1Mbps CNet network controller and driver interface;
- 4-channels serial communication controller, supports ModbusRTU master protocol, can be configured as either 4 independent or 2 pairs of 1:1 redundant communication interface; Supports Modbus RTU slave protocol, any RS-485 interface can link to the Modbus master protocol;
- 4-channels isolated RS-485 communication interface; complete galvanic isolation between module and external instrumentations;
- Communication interface has network failure protection and ESD protection, enhancing reliability of communication interface and network;
- System automatically recognize external modules type, and process as soon as inserted;
- Over-current protection that protects the module when abnormal high input current caused by malfunctioning of external modules happens. Module recovers after fault excluded.

Technical Parameters:

Item	Parameter
Communication Interface	4-channel Isolated RS-485
Communication Protocol	ModbusRTU Master Protocol, Slave Protocol
Communication Interface Load	Max 32 nodes
Register Size	AI (Input Register) :1024 AO (Holding Register) :512 DI (Input Coil) :1024 DO(Holding Coil):1024
Communication Commands Load	Max 256 commands
Redundancy Mode	2 pairs of 1:1 redundancy
Communication Distance	1km@4800bps
Isolation Voltage	2000V@60S
Immunity	EN61000-4-2 (ESD), level 3; EN61000-4-3 (RS), level 3 EN61000-4-4 (EFT), level 3; EN61000-4-5 (Surge), level 3 EN61000-4-6 (CS), level 3
Module Size	266mm×81mm×157mm
Power Consumption	2.5W
Working Temperature	-20° C ~ 60° C
Terminal Chassis	UW5174 Specialized Terminal Chassis for Modbus Communication Modules.

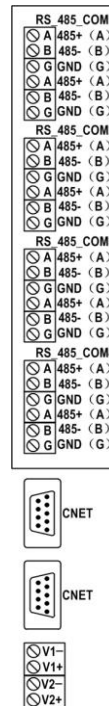

MODBUS Application Instruction

UW5131 Modbus communication Module supports 4 groups 32 slave station instrumentations. Each group separately sets communication parameters and field intelligent instrumentations communication management information. Configuration optionally the register area & address and real-time database connection map; It is suggest that each control module configured the most 4 Modus modules, you can set the reasonable communication parameters according the timely request.

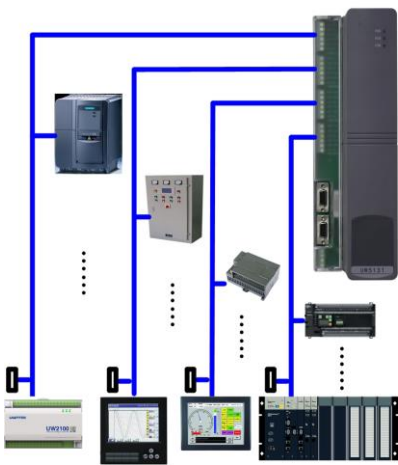

Hardware Configuration:

- Slave Communication instrumentation(Third-party intellectual instrumentation) must support the standard Modbus RTU slave protocol, such as PLC, intellectual instrumentation, Converter, Mass flow meters etc field intelligent instrumentation;
- Parameters of slave communication instrumentations connected to same RS-485 bus need to be same;
- 4 -channels Modbus communication interface share the device node space, flexible configuration according the field requirements, our suggest each interface load less than 16-nodes from slave station, total load 32 nodes, the address is not repeat use;
- Communication commands of Modbus communication module is no more than 256 pieces. Reasonable configured commands can improve the communication efficiency;
- Supports Modbus RTU slave protocol, any TS-485 interface can link the Modbus master protocol;
- The communication cables of RS-485 interface need the shielded twisted pair, wire diameter more than or equal to 0.75 square meter, or use the shielded cables;
- About the shielded twisted cable, the specification of our suggestion is RVSP 2*0.75, the wire resistant in 100meter is less than 4-ohm;
- UW5174 specialized terminal chassis for Modbus communication Module, with 4-channels COM communication interface, which is embedded termination resistor, only need to link the 120-ohm termination resistor at the terminal of linked equipments bus cable;
- The wiring of RS-485bus is request that isolated from strong interferers, and routed without in the same path;

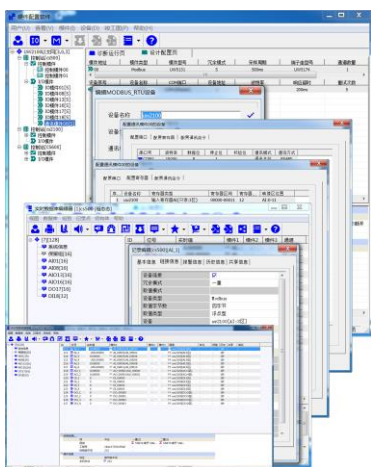

Software Configuration:

- Build field intelligent equipment in Hardware Configuration Software, establish linked communication interfaces(COM1-COM4) , address of equipment, and communication management information;
- Parameters of equipment communication interface: Data bits(7 bits, 8bits), Stop bits(1bits, 2bits), Baud rates(1200-115200bps),examination method (No calibration , Odd, Even);
- Follow the device instructions from the TriStation to choose the device register domain and address;
- Real-database inserted the record points, choose 2 bytes or 4 bytes under the analog record points connection, Respectively connected record points according the slave device registers table;
- Debugging and confirming the Modbus configuration and in normal operation;
- Slave configuration only need to set the interface in slave mode.

Field intelligent device or controllers usual used as industrial facility unit, such as filed local display, operation, control, communication etc, with small scope, multi-IO types, multi-communications modes(wired, wireless, local and wide area), Remote Distributed, Hybrid Control, Configurable HMI etc features; We develop the UW2100 interchangeable and intelligent controller in order to completely integrated UW500 distributed control system, and built the unified communication connector interface and overall database platform to realize the unified develop environment for control programmatically and support relative project engineering resource sharing; UW2100 supply the separate&abundant IO channels, open internet communication capacity, strong Local control operation; it is suitable for highly dispersed or wide dispersive automatic application area; It is formed large scale control system and network monitoring system according the internet connection between UW2100 and UW500 system.

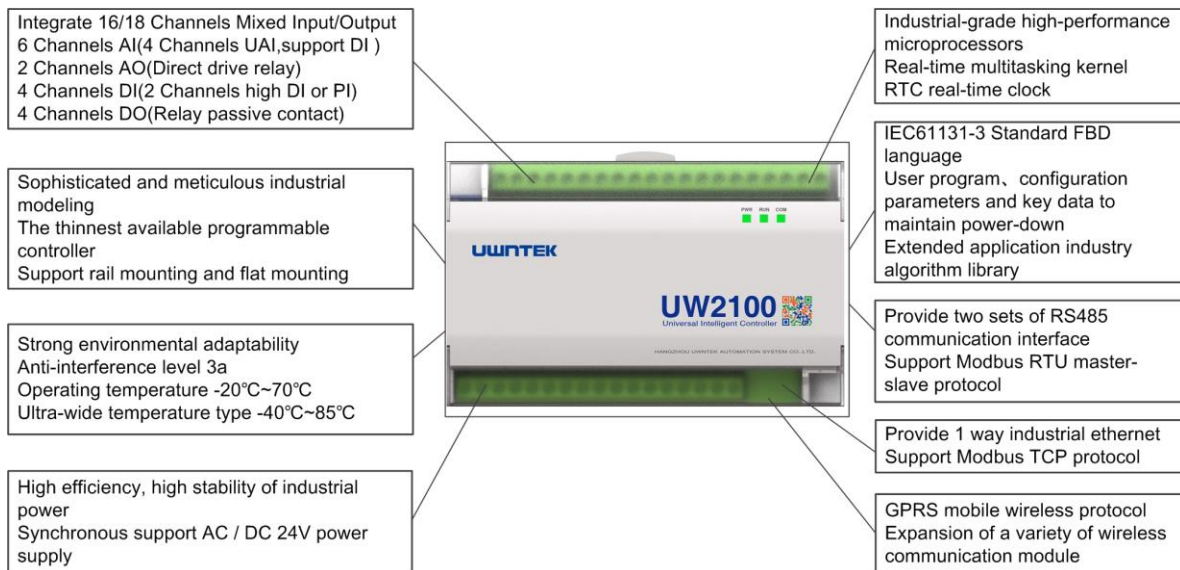

3.4 UW5132 Remote I/O Communication Module







UW5132 Remote I/O Communication Module realizes communication with Remote I/O Stations, it supports all the I/O Modules in UW500 DCS series. A single Remote I/O Station can be configured maximum 16 sets of I/O Modules. UW5132 installed internal dual-redundancy isolated CAN-Bus and dual-redundancy Multi-mode Optic Fiber, where each option could be selected due to application requirements; For CAN-Bus, maximum distance of Remote I/O Station is 100m; If applied Multi-mode Optic Fiber, maximum distance of Remote I/O Station can be as far as 2km, moreover, because of its immunity to Electro-Magnetic Interference, lighting strike & surge, chemical corrosion, the security & effectiveness of transmission data is enhanced; UW5132 Remote I/O Communication Modules are configured in pairs.

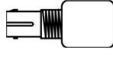
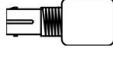
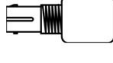
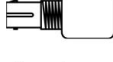

Functional Characteristics:

- Provides 2-channels redundant isolated CAN (controller area network) communication interface with network failure protection, ESD protection, etc. Can reliably realize connection with remote I/O stations in the range of 100m;
- Provides 4-Channels redundant ST multi-mode fiber interface, adaptive to connections with remote I/O stations in far-distance (2km) or in harsh environment;
- Status indicator equipped, featuring: running, fault, network (com) etc, clear running status help you locate error points efficiently;
- Complete isolation between modules and system, preclude external disturbance;
- Transient-voltage/Surge protection, modules Removal/Insertion Under Power permissible ;
- One remote I/O station supports maximum 16 I/O modules;
- Over-current protection that protects the module when abnormal high input current caused when malfunctioning happens. Module recovers after fault excluded.

Technical Parameters:

Item	Parameter	
Communication Interface 1	2-channel Isolated CAN-Bus, Baud Rate 500kpbs, Communication Distance 100m	 TXD0
Communication Interface 2	2 groups of Optic Fiber communication, altogether 4 ST multi-mode fiber interface, Baud Rate 1Mbps, Communication Distance 2km	 RXD0
Communication Interface Load	Max 16 I/O Modules per Remote Station	 TXD1
Redundancy Mode	2 pairs of 1:1 redundancy	 RXD1
Isolation Voltage	2000V@60S	 CBUS1
Immunity	EN61000-4-2 (ESD), level 3; EN61000-4-3 (RS), level 3 EN61000-4-4 (EFT), level 3; EN61000-4-5 (Surge), level 3 EN61000-4-6 (CS), level 3	 CBUS2
Module Size	266mm×81mm×157mm	 CNET
Power Consumption	2.5W	 CNET
Working Temperature	-20° C~60° C	
Terminal Chassis	UW5175 Specialized Terminal Chassis for Remote I/O Communication Modules	

3.5 UW5211 16 Channels HEART Analog Input Module

UW5211 HEART Analog Current Input Module realizes 4-20mA analog signal input, with functions featuring programmable amplification, date conversion, error detection, digital filtering, linearity correction, industrial transforming, etc. It supports HEART Equipment Communication and instrument equipment management (AMS); Communication of HART equipment does not affect the real-time data acquisition and procession. Hardware configuration software with the instrument equipment system manage, is convenient for users to remote view, edit, configure field devices record all the related operations, and improve maintenance efficiency with integrated digital signal between the each Heart field devices and conventional digital signal in the same platform.

HEART (Highway Addressable Remote Transducer) with the open communication protocol, supports the communication protocol between the field instrumentation and equipment in control room; Based Bell202 standard Frequency Shift Keying (FSK)signal, supports the bidirectional digital communication with 1.2Mbps data transfer rate under the condition of superimposed signal between 4-20mA low- frequency and 0.5mA audio digital signal; Other information such as measurement instruments, process parameters, device configuration, calibration and diagnostic information can be transmitted besides the basis 4-20mA main variable information, which can implement the instrument management system AMS.

Functional Characteristics:

- Intelligent Conditioning, supporting HEART analog signal(4-20mA 16channels)input, with full-scale high accuracy;
- Online self-correction, Auto Self-adaptation of environment temperature, self-correction without correction, no further calibration or maintenance necessity;
- Complete isolation between modules and system; PhotoMos relays switching channels; Complete isolation between channels, so that precludes external disturbance;
- HEART facilities directly via UWnTeK control engineering application software platform to achieve the remote control management functions;
- Equipped with industrial wiring terminal sets, canceled accessories such as system rack, bottom support, terminal blocks and wiring cables for easier maintenance.
- Internal input voting algorithm, input self-diagnosis and error report mechanism; Optional Non-redundant/Redundant or combination configurations and configuration strategies based on each module;

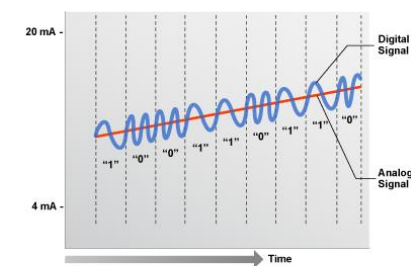

Note: Drawing not to scale

Digital over Analog

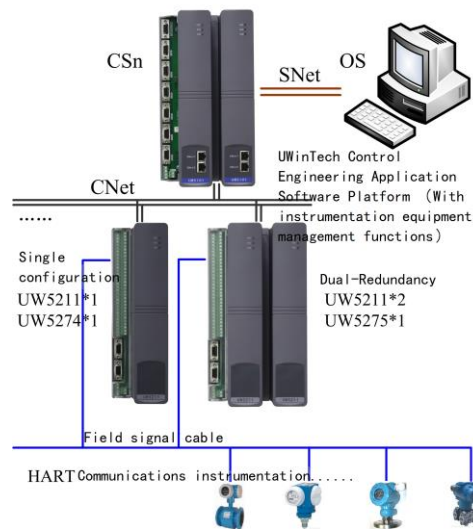
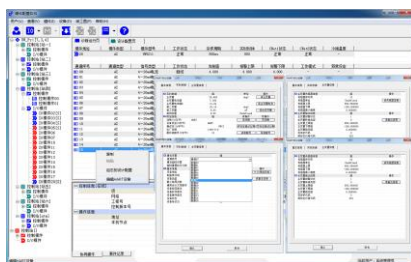

HART Equipment connection diagram

Technical Parameters:

Item	Parameter		
Channels	16		
Configuration			
Analogue Input	Current:4-20mA		
AI Sampling resolution	$\pm 0.1\%$ F.S.		
CMRR	≥ 120 dB		
DMRR	≥ 60 dB		
Isolation Impedance	$\geq 20M\Omega @ 500V$		
Immunity	EN61000-4-2 (ESD), level 3; EN61000-4-3 (RS), level 3 EN61000-4-4 (EFT), level 3; EN61000-4-5 (Surge), level 3 EN61000-4-6 (CS), level 3		
Module Size	266mm×81mm×157mm 266mm×146mm×157mm		
Power Consumption	1.5W		
Working Temperature	$-20^{\circ}C \sim 60^{\circ}C$		
Terminal Chassis	UW5274 Specialized Terminal Chassis for Analogue Input Modules UW5275 Specialized Terminal Chassis for Analogue Input Modules with Dual-Redundancy.		
			<p>Current input</p> <p>2-wire Current input with powering</p> <p>3-wire Current input with powering</p>

3.6 UW5212 16 Channels Large-Signal Analog Input Module

UW5212 16 Channels Large-Signal Analog Input Module realizes 16-channels 0~10mA、0~20mA、4~20mA、0~5V、1~5V analog signal input, with functions featuring signal type selection, programmable amplification, data conversion, error detection, digital filtering, temperature compensation, linearity correction, industrial transforming, etc.

Functional Characteristics:

- Intelligent conditioning, supports 16-channels 0~10mA、0~20mA、4~20mA、0~5V、1~5V analog signal input, software selects signal types, full-scale high accuracy;
- On-process self-diagnostic, automatic ambience-temperature compensation and zero & gain correction; No further calibration or maintenance necessity; automatic off-line detection;
- Complete isolation between Modules and system; PhotoMos relays switching channels; Complete isolation between channels so that precludes external disturbance;
- low-power-consumption designed Modules with expanded working temperature range;
- Equipped with industrial wiring terminal sets, cancelled accessories such as system rack, bottom support, terminal blocks and wiring cables for easier maintenance;
- Internal optional input voting algorithm, input self-diagnosis and error report mechanism; Optional Non-Redundant/Redundant configurations and configuration strategies based on single Module.



Technical Parameters:

Item	Parameter		
Channels Configuration	16		
Analog Input	Voltage: 0~5V、1~5V Current: 0~10mA、0~20mA、4~20mA		
AI Sampling Resolution	±0.1%F.S.		
CMRR	≥120dB		
DMRR	≥60dB		
Isolation Impedance	≥20MΩ@ 500V		
Immunity	EN61000-4-2 (ESD), level 3; EN61000-4-3 (RS), level 3 EN61000-4-4 (EFT), level 3; EN61000-4-5 (Surge), level 3 EN61000-4-6 (CS), level 3		
Module Size	266mm×81mm×157mm 266mm×146mm×157mm		
Power Consumption	1.5W		
Working Temperature	-20°C~60°C		
Terminal Chassis	UW5274 Terminal Chassis for Analog Input UW5275 Specialized Terminal Chassis for Analog Input with Dual-Redundancy		

3.7 UW5213 16 Channels TC Analog Input Module

UW5213 16 Channels TC Analog Input Module realizes 16-channels Thermo-Couple (TC) analog signal input, with functions featuring signal type selection, programmable amplification, data conversion, error detection, digital filtering, temperature compensation, linearity correction, industrial transforming, etc.

Functional Characteristics:

- Intelligent conditioning, supports 16-channels Thermo-Couple (TC) analog signal input, software selects signal types (Thermo-couple type B、K、E、S、T、R、N、J), full-scale high accuracy;
- On-process self-diagnostic, automatic ambience-temperature compensation and zero & gain correction; No further calibration or maintenance necessity; automatic off-line detection;
- Complete isolation between Modules and system; PhotoMos relays switching channels; Complete isolation between channels so that precludes external disturbance;
- low-power-consumption designed Modules with expanded working temperature range;
- Supports Thermo-Couple Automatic Cold-junction Compensation; TC breakdown self-diagnosis and fault treatment;
- Equipped with industrial wiring terminal sets, cancelled accessories such as system rack, bottom support, terminal blocks and wiring cables for easier maintenance;
- Internal optional input voting algorithm, input self-diagnosis and error report mechanism; Optional Non-Redundant/Redundant configurations and configuration strategies based on single Module.



Technical Parameters:

Item	Parameter		
Channels Configuration	16		
Analog Input	Voltage : 0 ~ 20mV, 0 ~ 100mV, ±20mV, ±100mV TC : type B、K、E、S、T、R、N		
AI Sampling Resolution	±0.1%F.S. (Cold Junction Error not included)		
Cold Junction Error	±2 °C		
CMRR	≥120dB		
DMRR	≥60dB		
Isolation Impedance	≥20MΩ@ 500V		
Immunity	EN61000-4-2 (ESD), level 3; EN61000-4-3 (RS), level 3 EN61000-4-4 (EFT), level 3; EN61000-4-5 (Surge), level 3 EN61000-4-6 (CS), level 3		
Module Size	266mm×81mm×157mm 266mm×146mm×157mm		
Power Consumption	1.5W		
Working Temperature	- 20°C ~ 60°C		
Terminal Chassis	UW5271 Terminal Chassis for Analog Input/output UW5272 Specialized Terminal Chassis for Analog Input with Dual-Redundancy		<p>TC input</p>

3.8 UW5214 16 Channels RTD Analog Input Module

UW5214 16 Channels RTD Analog Input Module realizes 16-channels Thermo-resistance / Resistance Temperature Detector (RTD) analog signal input, with functions featuring signal type selection, programmable amplification, data conversion, error detection, digital filtering, temperature compensation, linearity correction, industrial transforming, etc.

Functional Characteristics:

- Intelligent conditioning, supports 16-channels Thermo-resistance / Resistance Temperature Detector (RTD) analog signal input, software selects signal types (Thermo-Resistor / Resistance Temperature Detector type Pt100, Pt100A, Cu50), Resistance Type(0~400Ω),full-scale high accuracy;
- On-process self-diagnostic, automatic ambience-temperature compensation and zero & gain correction; No further calibration or maintenance necessity; automatic off-line detection;
- Complete isolation between Modules and system; PhotoMos relays switching channels; Complete isolation between channels so that precludes external disturbance;
- low-power-consumption designed Modules with expanded working temperature range;
- Supports Thermo-resistance / Resistance Temperature Detector breakdown self-diagnosis and fault treatment;
- Equipped with industrial wiring terminal sets, cancelled accessories such as system rack, bottom support, terminal blocks and wiring cables for easier maintenance;
- Internal optional input voting algorithm, input self-diagnosis and error report mechanism; Optional Non-Redundant/Redundant configurations and configuration strategies based on single Module.



Technical Parameters:

Item	Parameter	
Channels Configuration	16	
Analog Input	RTD: Pt100、 Pt100A、 Cu50、 0~400Ω	
AI Sampling Resolution	±0.1%F.S.	
CMRR	≥120dB	
DMRR	≥60dB	
Isolation Impedance	≥20MΩ@ 500V	
Immunity	EN61000-4-2 (ESD), level 3; EN61000-4-3 (RS), level 3 EN61000-4-4 (EFT), level 3; EN61000-4-5 (Surge), level 3 EN61000-4-6 (CS), level 3	
Module Size	266mm×81mm×157mm	
Power Consumption	1.5W	
Working Temperature	-20° C~60° C	
Terminal Chassis	UW5271 Terminal Chassis for Analog Input/Output	

3.9 UW5231 16 Channels Mixed Analog Input/Output Module

UW5231 Mixed Analog Input/Output Module Realizes maximum 16-channels Mixed analog inputs and/or outputs. Supports to-channel isolation, channel-to-channel inter-isolation, to-channel power supply, to-channel Removal/Insertion Under Power.

Functional Characteristics:

- High-reliability Sub-modules, to-channel isolation, channel-to-channel inter-isolation, to-channel power supply, to-channel Removal/Insertion Under Power, meeting requirements of high reliability & security fields like nuclear power and emergency shutdown;
- Intelligent conditioning, supports 16-channels analog signal (voltage/current/TC/RTD/pulses) input, software selects signal types, full-scale high accuracy, self-correction and no further calibration or maintenance necessity;
- I/O Sub-modules connected by digital bus, non-destructive data transmission, supports I/O Sub-modules automatic recognition, automatic configure and Removal/Insertion Under Power;
- Status indicator equipped on Modules as well as Sub-modules, featuring: running, fault, network (com) etc, clear running status help you locate error points efficiently;
- Optional internal input voting algorithm, output voting algorithm, input/output self-diagnosis and error report mechanism; Optional Non-redundant/Redundant configurations and configuration strategies based on single channel;
- Equipped with industrial wiring terminal sets, cancelled accessories such as system rack, bottom support, terminal blocks and wiring cables for easier maintenance.



Technical Parameters:

Item	Parameter	
Channels	AI, or AO, or PI, max 16 Sub-Modules in total	
Analog Input	Voltage: 0~20mV, 0~100mV, 0~5V, 1~5V Current: 0~10mA, 0~20mA, 4~20mA RTD: Pt100, Pt100X, Cu50 TC: type B, E, J, K, S, T	
Analog Output	Current: 0~10mA, 0~20mA, 4~20mA	
AI Sampling resolution	±0.1%F.S.	
AO Output Resolution	±0.1%F.S.	
CMRR	≥120dB	
DMRR	≥60dB	
Isolation Impedance	≥20MΩ@ 500V	
Immunity	EN61000-4-2 (ESD), level 3; EN61000-4-3 (RS), level 3 EN61000-4-4 (EFT), level 3; EN61000-4-5 (Surge), level 3 EN61000-4-6 (CS), level 3	
Module Size	266mm×81mm×157mm 266mm×146mm×157mm	
Power Consumption	16W	
Working Temperature	-20° C~60° C	
Terminal Chassis	UW5271 Terminal Chassis for Analog Input/output UW5272 Specialized Terminal Chassis for Analog Input with Dual-Redundancy UW5277 Specialized Terminal Chassis for Analog Output with Dual-Redundancy	

3.9.1 UW5261 Universal Analog Input Sub-module

UW5261 Universal Analog Input Sub-module realizes single-channel analog signal input, with functions featuring signal type selection, programmable amplification, data conversion, error detection, digital filtering, temperature compensation, linearity correction, industrial transforming, etc. Supports universal inputs and Removal/Insertion Under Power.



Functional Characteristics:

- Supports universal analog signal (voltage/current/RTD/TC) input, full-scale high accuracy;
- Automatic ambience temperature compensation and zero point & gain calibration, no further calibration or maintenance necessity;
- On-line self-diagnosis and running status indicator, fast locating error channel;
- Automatically recognizes off-line, TC signal automatic cold-junction compensation;
- Complete isolation between Modules and system, complete isolation between channels, so that precludes external disturbance;
- Provides +24V/30mA isolated power supply for direct powering to two-wire / three-wire transmitters in the field, which reduced configuration costs as well as project workload, and significantly improved system immunity & stability;
- Transient-Voltage-Surge Protection and RIUP circuit, supports Removal/Insertion Under Power and on-process replacement;
- Less ripples, less temperature shift, more efficient, more reliable, better voltage isolation withstand. Protection functions include soft-start, input short-circuit protection, output power limitation, channel power-supply current limitation, etc.

Technical Parameters:

Item	Parameter	
Input Signal	Voltage: 0~20mV、0~100mV、0~5V、1~5V Current: 0~10mA、0~20mA、4~20mA RTD: Pt100、Pt100X、Cu50 TC: type B、E、J、K、S、T	
Input Impedance	Voltage signal: 2MΩ; Current signal: 75Ω	
Isolation Impedance	20MΩ@ 500V	
CMRR	>120dB	
DMRR	>60dB	
Input Resolution	±0.1% F.S.	
Power Consumption	1W(channel powering); 0.5W(channel not powering)	
Module Size	115mm×51mm×13mm	

3.9.2 UW5264 Pulses Input Sub-module

UW5264 Pulses Input Sub-module realizes signal Pulse Counting / Frequency Counting function. It also has off-line data-holding function for pulses accumulation. Supports Removal/Insertion Under Power.



Functional Characteristics:

- Supports a variety of pulse input types, including Voltage pulse: 12V, 24V; Current pulse: 0-10mA, 4-20mA; Frequency Range: 0-30KHz;
- Pulses input Photo-Electric Isolation, with isolation voltage of 2000V@60s;
- Supports synchronous Pulse Counting + Frequency Counting on pulses signal;
- Off-line data-holding function for pulses accumulation;
- On-line self-diagnosis and running status indicator, fast locating error channel;
- Completely isolated between the Modules&Systems, Sub-modules by Built-in Isolated fence to resist external interference;
- Transient-Voltage-Surge Protection and RIUP circuit, supports Removal/Insertion Under Power and on-process replacement;
- Less ripples, less temperature shift, more efficient, more reliable, better voltage isolation withstand. Protection functions include soft-start, input short-circuit protection, output power limitation, channel power-supply current limitation, etc.

Technical Parameters:

Item	Parameter	
Input Signal	Voltage 1: 12V, low=0~5V, high=6~12V Voltage 2: 24V, low=0~12V, high=12~30V Current 1: 10mA, low=0~2mA, high=4~10mA Current 2: 20mA, low=4~8mA, high=12~20mA	
Functions	Pulse Counting ; Frequency Counting; Pulse Counting + Frequency Counting	
Input Frequency	0~30kHz	
Maximum Counting Value	6 Bytes	
Isolation Voltage	2000V@60s	
Power Consumption	1W(channel powering); 0.5W(channel not powering)	
Module Size	115mm×51mm×13mm	

3.9.3 UW5266 Analog Output Sub-module

UW5266 Analog Output Sub-module realizes single-channel analog data calibration, latch & output protection. According to configuration, can realize output data holding or output set value in abnormal conditions. Supports Removal/Insertion Under Power.



Functional Characteristics:

- Supports universal analog signal (0~10mA, 4~20mA or 0~20mA, configured through software) DC output;
- Automatic ambience temperature compensation and zero point & gain calibration, no further calibration or maintenance necessity;
- On-line self-diagnosis and running status indicator, fast locating error channel;
- Automatically recognizes off-line, TC signal automatic cold-junction compensation;
- Complete isolation between Modules and system, complete isolation between channels, so that precludes external disturbance;
- Abnormal condition configuration, can select either output-holding or output user-set value when abnormal conditions happen;
- Transient-Voltage-Surge Protection and RIUP circuit, supports Removal/Insertion Under Power and on-process replacement;
- Less ripples, less temperature shift, more efficient, more reliable, better voltage isolation withstand. Protection functions include soft-start, input short-circuit protection, output power limitation, channel power-supply current limitation, etc.

Technical Parameters:

Item	Parameter	
Output Signal	Current: 0~10mA, 4~20mA, 0~20mA	<p>All Sub-Modules support RIUP and On-process Replacement</p>
Isolation Impedance	20MΩ@500V	
Load Capacity	1500Ω@0~10mADC, 750Ω@4~20mADC	
Output Linearity	±0.1% F.S.	<p>UW5266 Isolated Electrical Schematic</p>
Output Resolution	±0.1% F.S.	
Power Consumption	1W	
Module Size	115mm×51mm×13mm	

3.10 UW5311 32 Channels Digital Input Module

UW5311 32-Channel Integrated Digital Input & Conditioning Module realizes 32 channels digital/switch/binary signal input.



Functional Characteristics:

- System automatically recognize Modules type, and process as soon as inserted;
- Photo-electric isolation between field signals and system with maximum isolation voltage of 2000V;
- Inter-isolation between channels, so single channel failure does not influence the functioning of other channels;
- System channel powering and system power supply are fed respectively by two individual +24V power supplies, thus completely isolated with each other;
- Over-current protection that protects the module when abnormal high input current caused when malfunctioning happens. Module recovers after fault excluded;
- Equipped with industrial wiring terminal sets, cancelled accessories such as system rack, bottom support, terminal blocks and wiring cables for easier maintenance;
- Internal optional input voting algorithm, output voting algorithm, input/output self-diagnosis and error report mechanism; Optional Non-redundant/Redundant configurations and configuration strategies based on single Module.

Technical Parameters:

Item	Parameter	
Channels Configuration	32 channels digital input	
Scanning Period	2ms	
Logic 1 (low)	Closed contact impedance <math>< 1K\Omega</math> (when installed on UW5371) Voltage contact 18~30VDC (when installed on UW5374)	
Logic 0 (high)	Open contact impedance >math>> 35K\Omega</math> (when installed on UW5371) Voltage contact 0~5VDC (when installed on UW5374)	
Immunity	EN61000-4-2 (ESD), level 3; EN61000-4-3 (RS), level 3 EN61000-4-4 (EFT), level 3; EN61000-4-5 (Surge), level 3 EN61000-4-6 (CS), level 3	
Module Size	266mm×81mm×157mm 266mm×146mm×157mm	
Power Consumption	1W	
Channel Powering	10mA/CH @24VDC(when installed on UW5371)	
Working Temperature	-20°C~60°C	
Terminal Chassis	UW5371 Terminal Chassis for Digital Input UW5372 Specialized Terminal Chassis for Digital Input with Dual-Redundancy UW5374 Terminal Chassis for Digital Level-Input UW5376 Terminal Chassis for 16-Channel AC Isolated Relay Input	

3.11 UW5322 16 Channels Digital Output Module

UW5322 16-Channel Integrated Digital Output Module realizes 16 channels digital/switch/binary signal output.

Functional Characteristics:

- System automatically recognize Modules type, and process as soon as inserted;
- Photo-electric isolation between field signals and system with maximum isolation voltage of 2000V;
- Inter-isolation between channels, so single channel failure does not influence the functioning of other channels;
- System channel powering and system power supply are fed respectively by two individual +24V power supplies, thus completely isolated with each other;
- Over-current protection that protects the module when abnormal high input current caused when malfunctioning happens. Module recovers after fault excluded;
- DO channels output data read-back, ensures reliability of output data;
- Equipped with industrial wiring terminal sets, cancelled accessories such as system rack, bottom support, terminal blocks and wiring cables for easier maintenance;
- Internal optional input voting algorithm, output voting algorithm, input/output self-diagnosis and error report mechanism; Optional Non-redundant/Redundant configurations and configuration strategies based on single Module.



Technical Parameters:

Item	Parameter		
Channels Configuration	16 channels digital output	⊙ 0A ⊙ 0B ⊙ /0B ⊙ 1A ⊙ 1B ⊙ /1B ⊙ 2A ⊙ 2B ⊙ /2B ⊙ 3A ⊙ 3B ⊙ /3B ⊙ 4A ⊙ 4B ⊙ /4B ⊙ 5A ⊙ 5B ⊙ /5B ⊙ 6A ⊙ 6B ⊙ 7A ⊙ 7B ⊙ 8A ⊙ 8B ⊙ 9A ⊙ 9B ⊙ 10A ⊙ 10B ⊙ 11A ⊙ 11B ⊙ 12A ⊙ 12B ⊙ 13A ⊙ 13B ⊙ 14A ⊙ 14B ⊙ 15A ⊙ 15B	⊙ 0A ⊙ 0B ⊙ 1A ⊙ 1B ⊙ 2A ⊙ 2B ⊙ 3A ⊙ 3B ⊙ 4A ⊙ 4B ⊙ 5A ⊙ 5B ⊙ 6A ⊙ 6B ⊙ 7A ⊙ 7B ⊙ 8A ⊙ 8B ⊙ 9A ⊙ 9B ⊙ 10A ⊙ 10B ⊙ 11A ⊙ 11B ⊙ 12A ⊙ 12B ⊙ 13A ⊙ 13B ⊙ 14A ⊙ 14B ⊙ 15A ⊙ 15B
Scanning Period	2ms		
Contact Capacity	10A @250VAC, 10A@30VDC		
Contact Lifespan	>100000 times		
Immunity	EN61000-4-2 (ESD), level 3; EN61000-4-3 (RS), level 3 EN61000-4-4 (EFT), level 3; EN61000-4-5 (Surge), level 3 EN61000-4-6 (CS), level 3		
Module Size	266mm×146mm×157mm		
Power Consumption	1W		
Channel Powering	40mA/CH @24VDC		
Working Temperature	-20°C~60°C	CNET 	CNET
Terminal Chassis	UW5381 Terminal Chassis for Relay Output UW5382 Terminal Chassis for Digital Output with Dual-Redundancy UW5385 Terminal Chassis for Relay Level-Output	⊙ V1- ⊙ V1+ ⊙ V2- ⊙ V2+ ⊙ P24- ⊙ P24+	⊙ V1- ⊙ V1+ ⊙ V2- ⊙ V2+ ⊙ P24- ⊙ P24+
		UW5381	UW5385

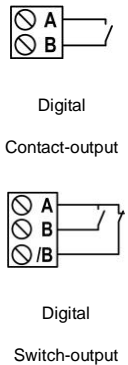

3.12 UW5341 32 Channels SOE Recorder Module

UW5341 32 Channels Sequence-of-Events Recorder Module Realizes 32-channels digital (voltage-level) signal synchronously; Records Sequences and Time of Events happened, with resolution up to 1ms;



Functional Characteristics:

- System automatically recognize Modules type, and process as soon as inserted;
- Hardware real-time sampling technology, SOE recording resolution up to 1ms;
- Isolation between field signals and system with maximum isolation voltage of 2000VAC @ 60s;
- Module power supply reverse-connection protection, over-voltage/over-current protection, improving Module’s reliability;
- Maximum 256 binary-value points under SOE recording on every Control Station; Maximum capacity 32768 events to be recorded on every Control Station;

Technical Parameters:

Item	Parameter	
Channels Configuration	32 channels digital level-input	
Scanning Period	0.5ms	
Recording Resolution	1ms	
Logic 1(low)	Closed contact impedance<1KΩ (when installed on UW5375) Voltage contact 18~30VDC (when installed on UW5374)	
Logic 0 (high)	Open contact impedance>35KΩ (when installed on UW5375) Voltage contact 0~5VDC (when installed on UW5374)	
SOE Capacity	1024	
Immunity	EN61000-4-2 (ESD), level 3; EN61000-4-3 (RS), level 3 EN61000-4-4 (EFT), level 3; EN61000-4-5 (Surge), level 3 EN61000-4-6 (CS), level 3	
Power Consumption	1W	
Channel Powering	15mA/CH @24VDC (UW5375)	
Module Size	266mm×81mm×157mm	
Working Temperature	-20°C~60°C	
Terminal Chassis	UW5374 Terminal Chassis for Digital Level-Input UW5375 Terminal Chassis for Digital Switch-Input	

3.13 UW5411 System Power Supply Module

UW5411 System Power Modules supply the completely isolated 24V DC output voltage, as system power source supply the control station, including control modules, IO modules etc; supply the third-part power, realize the 24V DC output power distribution, cancel terminal blocks and the series of complicated engineering accessories, simple and easy for application, together with the exchangeable 1A fuse, improve the convenient for fuse-replacement; improve the reliability of terminal block by using the Phoenix industrial connection terminal groups. UW5411 System Power support 1:1 redundancy;



Functional Characteristics:

- Applied professional PWM power supply MCU to approach close-loop control functions like voltage regulating, current regulating, protection, etc. Stable power supply output with high efficiency and reliability;
- Supports 1:1 Power Supply Modules High-Available Redundancy;
- Input over-voltage/under-voltage protection (220VAC±20%);
- Output over-current protection (110~115% of rated);
- Low susceptibility to grid voltage fluctuation, strong adaptability to output loads;
- Equipped with industrial wiring terminal sets, cancelled accessories such as system rack, bottom support, terminal blocks and wiring cables for easier maintenance;

Technical Parameters:

Item	Parameter	
Input Power	Input voltage range: 176~264VAC Input frequency range: 50 ±3Hz	
Rated Load	Nominal Value 170VA	
Regulated Output	V1/V2 isolated 2-channel output voltage: 24.0Vdc, accuracy±5%, output current 7.00A dc	
Regulation Capability	Voltage regulation ≤1% (full temperature range) Load regulation ≤5% (0~125% of rated load range)	
Immunity	EN61000-4-2 (ESD), level 3; EN61000-4-3 (RS), level 3 EN61000-4-4 (EFT), level 3; EN61000-4-5 (Surge), level 3 EN61000-4-6 (CS), level 3	
Isolation Voltage	≥2500V	
Isolation Impedance	≥50MΩ	
Module Size	266mm×146mm×157mm	
Working Temperature	-20°C~60°C	
Terminal Chassis	UW5472 Specialized Terminal Chassis for Power Supply Modules with Dual-Redundancy	

3.14 Cabinet and Accessories

UW500 Distributed Control System applies modular structure, Modules are matched with certain Terminal Chassis, and Terminal Chassis are connected to Controller Modules with specialized communication cables; No need for specialized system rack, terminal blocks or their connection parts, simple structure, clear distribution, strong adaptation to cabinets, suitable for integration installation by engineering companies and terminal users; No specialized requirement for cabinet, and hereby we just provide two standardized cabinet for your designing reference; User can either choose one according to system requirements, or customize according to field conditions.

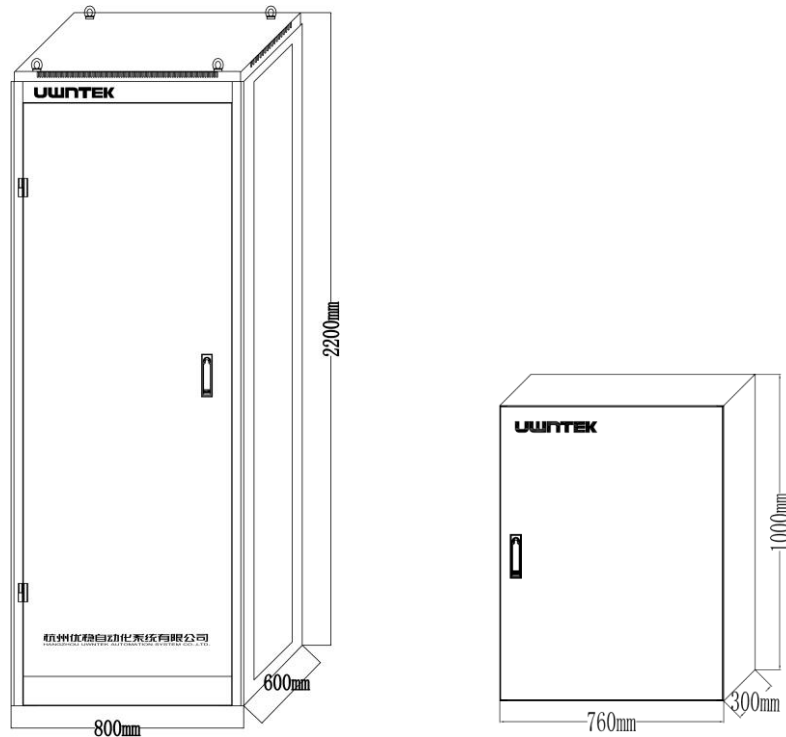

Controller Modules, Power Supply Modules and I/O Modules are possible to install on both sides inside of the Control Station cabinet; Modules can be distributed in 2 columns, 3 columns or 4 columns according to distribution requirements; C.S. cabinet is specially manufactured, meeting principles of ventilation & heat-dissipation, humidity-proof & corrosion-proof, safety & protection, etc, cabinet installed forced ventilation fan in order to provide forced cooling air and also to hold positive pressure inside, in this way heat-dissipation and dust-proof are both achieved; Cabinet case is made of metallic materials, and good electrical connections are ensured between movable components, so that perfect EMS (Electro-magnetic Shielding) is provided for internal electronic devices. To guarantee EMS effectiveness and operators' safety, we request the cabinet to be connected to Electrical Ground (Protection Ground) with connecting resistance less than 5 Ohm; Movable cable ducts installed on side of the cabinet back. On cabinet bottom there are multiple cable inlets, as well as copper ground terminals for converging system ground and shielding ground.



UW5531 Modules Communication Cable (0.6m)

Chapter 4 Operator/Engineering Station

System Operator Stations are devices to be used by industry field operators. By using keyboard or mouse, operators are able to supervise process variables flexibly, conveniently and accurately, and to modify process parameters according to process changes. Engineering Stations are used for configuring function and downloading configuration data for application system, moreover, they can also handle process supervision instead of Operator Stations. Hardware of Engineering Stations is not necessary to be configured individually ---- on the other hand, any O.S. in the system can take over the E.S. responsibility. Main functions of O.S. and E.S. are:

- Display self-diagnosis information of the entire system in order to help maintenance staffs to acknowledge the running status of the system.
- Obtain field information from Field Control Stations, realize functions including data supervision, saving error & alarm information, saving history data, data statistics report, etc. Send commands or configuration data to Field Control Stations.
- Send manufacturing data and statistics information to management level computers through MNet (Management Net), and obtain manufacturing execution commands from management level computers.

Hardware of an Operator Station consists of O.S. host PC, monitor, standard keyboard & mouse, System Net communication card, printer, operator desk, etc; Host PC of O.S. might be either an IPC (Industrial Personal Computer), or, if under the requests of the user, a stable and reliable business PC such as DELL, HP. Operation system of the host PC is WindowsNT/2000/XP, and the application software is UWinTech Control Engineering Application Software Platform.

Minimum recommended configuration of Industrial PC:

- Industrial-rank long-lifespan main board or business server;
- Intel 1GHz MCU;
- 512M DDR SDRAM;
- Hard Disk capacity ≥ 80 GB;
- Main board integrated graphics controller, dynamic memory sharing technology;
- At least 2 PCI or PCI-E slots.



UW565 Specialized Industrial Keyboard (IP67)

Operator Desk is totally metallic, both front door and back door can be opened, thus convenient for system maintenance by the user; Good electrical connections between movable components and desk body, provides good Electro-magnetic Shielding for internal electronic devices. To guarantee EMS effectiveness and operators' safety, we request the Operator Desk to be connected to Electrical Ground (Protection Ground) with connecting resistance less than 4 Ohm; In case that the system is equipped with multiple operator desks, desks would be placed side by side, and two nearby desks can be closed to each other so that to form an integrated large operator desk.

Unlike floor-type operator desk, our plane-type operator desk cancelled the upper structure, so monitor or printer could be directly placed on the desk plane. Moreover, plane-type operator desk can act as printer desk, and kinds of printers could be placed on it. Size of an Operator Desk: $W \times D \times H = 700\text{mm} \times 1118\text{mm} \times 750\text{mm}$, as showed below:

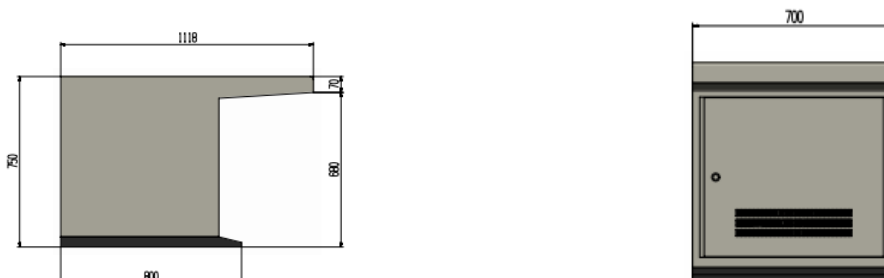

Chapter 5 UWinTech Control Engineering Application Software Platform

UWinTech Control Engineering Application Software Platform is a software package applied to UW500 Distributed Control System. Based on WindowsXP/Windows 7 32 Real-time Multi-task operational system, UWinTech applied Components Structure Design and latest technologies like 32 bits Multi-tasks and Multi-threads, integrated with comprehensive functions including Field Data Collection, Algorithm Execution, Real-time Data & History Data Processing, Alarm and Security Mechanism, Dynamic Display, Tendency Curves, Report Import/Export and Supervision Network. Engineer Station Configuration software, Operator Station Real-time Supervision software and Field Control Station Real-time Control software run separately on different hardware level, while communicate data, management and control information through Control Net and System Net, and hereby different parts of the software cooperate with each other and accomplish all kinds of functions of the control system.

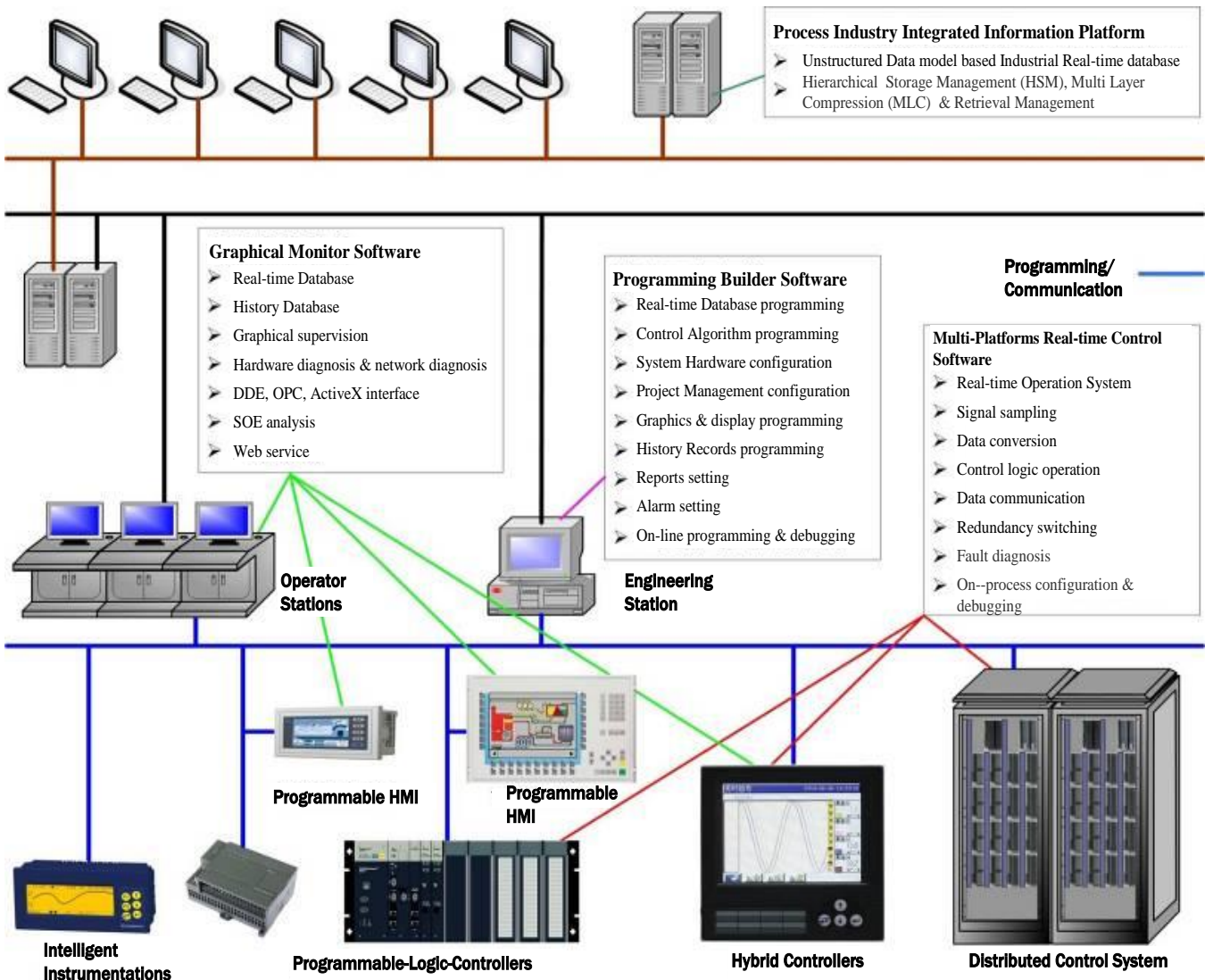

UWinTech Software Structure of Control Engineering Application Software Platform

5.1 Software Technical Characteristics

■ Control Engineering Design & Development Platform, which is based on Multi-Industry Engineering Objects Model, enables the founding of multi-industry description models library for rudimental elements, unit equipments and industry installations step by step, through establishing typical control engineering models library (static & dynamic models and technical data), control methods library (equipments control & process optimization algorithm, operation parameters), display interface library (display & operation panel) ---- “builds” equipments models through multiplexing, “constructs” operation program through “restructuring”, and further builds closely inter-related and physically meaningful Engineering Objects Models, Engineering Control Strategies and Supervision Operation Platform through multi-industry global modeling for abstract, separated and dispersed data (constant, parameter, variable) and functions (calculation, meaning) as well as graphics (line, polygon, color lump), finally ensures clear, figurative, efficient and reliable designing & programming for control engineering.

■ Real-time Tags Quality Stamps, extracted in order to indicate data quality status, combined with hardware redundancy status, cover information including channel abnormality, sampling bias, range overrun, network status, etc, therefore ensures reliability & credibility of real-time data; History Recording and Tracing Analysis for quality stamps and real-time values are supported.

■ Applied algorithm blocks package, data driving & events triggering-based distributed algorithm scheduling technology, which complies with IEC61131-3 International Electrotechnical Commission Standard for Programmable Logic Controllers; Integrated logic control, motion control and process control as an integration, developed and realizes integrated developing environment which supports graphical programming (FBD, LD, SFC) as well as text programming (ST, IL) and moreover, multi-language mixed programming; Supports control algorithm packaging, deriving, multiplexing; Realizes control algorithm off-line programming, on-line programming, off-line simulation and on-line debugging, all of which have improved programming efficiency.

■ Through open and standard OPC client-server interface, UWinTech has realizes data communication with third-party instrumentations by applying Transparent Network management technology.

Constructed Distributed Engineering Objects Real-time Database, realizes globally consistent & unified interface, fulfills the integrated-information & open-interface demands for multi-timings, multi-languages, multi-spaces and multi-scales characteristics of industrial data.

■ By accessing GPS global satellite clock, the system applied NTP (Network Time Protocol) to synchronize clocks of all the Control Stations and Operator Stations; Provide precise clock for Sequence of Events (SOE) recording; Provide global standard clock for data recording between all the Operator Stations.

■ Provides Control Engineering Industry Algorithm Library which is open to be customized and expanded. Through cooperation with design institutes, equipments manufacturers, engineering companies and industry users, we continuously enrich our professional knowledge on industry automation.

Industrial knowledge as fundamental, further supported by the framework of reusable



设备序号	设备名称	设备类型	工作电压	平均功率	额定功率	容量	备注
01	A2	控制柜	380V	100W	100W	100W	正常
02	A2	控制柜	380V	100W	100W	100W	正常
03	A2	控制柜	380V	100W	100W	100W	正常
04	A2	控制柜	380V	100W	100W	100W	正常
05	A2	控制柜	380V	100W	100W	100W	正常
06	A2	控制柜	380V	100W	100W	100W	正常
07	A2	控制柜	380V	100W	100W	100W	正常
08	A2	控制柜	380V	100W	100W	100W	正常
09	A2	控制柜	380V	100W	100W	100W	正常
10	A2	控制柜	380V	100W	100W	100W	正常
11	A2	控制柜	380V	100W	100W	100W	正常
12	A2	控制柜	380V	100W	100W	100W	正常
13	A2	控制柜	380V	100W	100W	100W	正常
14	A2	控制柜	380V	100W	100W	100W	正常
15	A2	控制柜	380V	100W	100W	100W	正常

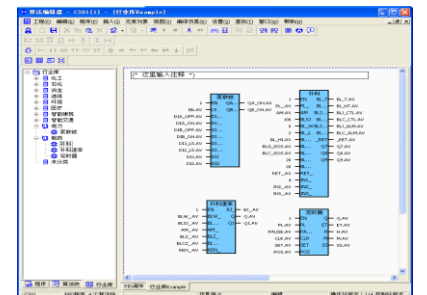
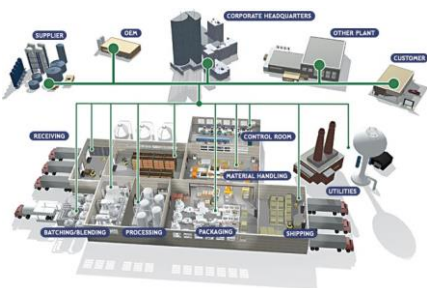
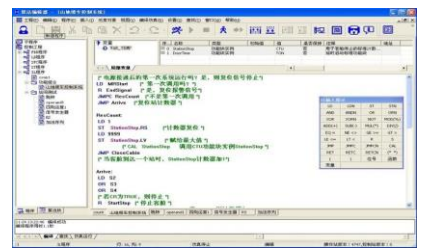
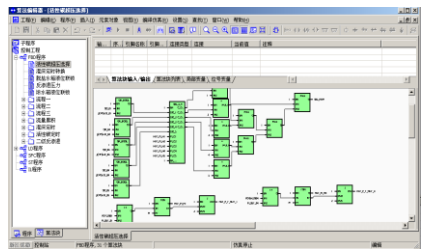

resources and reconstructable system, we significantly improved industrial design & programming efficiency through the mechanism of inheriting, deriving, multiplexing and reconstructing; Control Engineering Industry Algorithm Library possesses generality while also specialty of certain automation application. Regularly released in the form of industry packages, Algorithm Library can be conveniently accessed by the user through downloading.

■ The formula management and batch management, which are following the international standards SA-S88, with the function of decomposition production processes and authority control logic, realize the module package and process re-engineering on the basis of device, safety production to reduce production accidents. And also improve the production efficiency and equipment utilization by standardized production processes; divided the control engineer and process engineer, realize the batch production process and data encryption of the key parameters and prevent malicious tampering; Guarantee the equipment/process and operation safety. It successfully resolved the general automotive needs of intelligent manufacturing and Intellectual factory, effectively improve the competitiveness of factory;

■ Project Remote Updating function allows engineering service people to update project modifications through LAN or WAN, the advantage is that they no longer have to travel frequently between sites for minor project modifications.

■ Project Synchronous Configuration function meets requirements in super-large scale project. It ensures information consistency when multiple users are synchronously configuring one single project, in this way the time cost on project's early-stage configuration.

■ Project As-Built Drawing Exporting function provides an as-built drawing which indicates detailed project information. This is quite necessary after project configuration, debugging and starting.

■ Engineering Objects Structure configuration mode in RDB joints the discrete recording tags as integrations according to project's characteristics and achieves programming multiplexing (with control strategies at UWinIEC and display operation at UWinMaker), and thus improves program maintenance efficiency.

■ Abundant equipments graphs library and smart library management allow the user to utilize existing equipments conveniently, and also to modify based on existing graphs easily.

■ Microsoft Office PowerPoint style Template with page header/footer function supports graphics editing, and thus graphical distinctiveness and unity are both ensured. Moreover, supports Template Customizing.

■ Supports remote visiting to process supervision display ---- the user may easily visit process information through normal web browser while needs no software installation, while strict user-certification guarantees operation security.

■ Our distinctive Alarm Sound Family function makes alarm sound's setting very flexible and convenient. Together with Alarm Groups and Alarm Level functions, the alarm functions become more efficient, accurate and clear.

■ User-binding Function Zone & Security Zone function determines user authorities to log in a project. Flexible setting options fulfill requirements of industrial fields that have different stuffs with different operation authorities. In this way project safety and security are comprehensively protected.

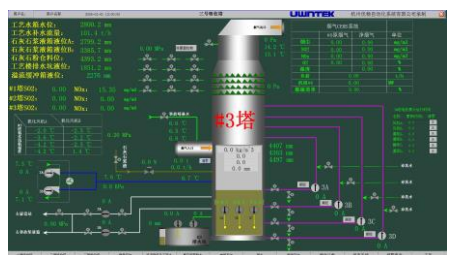
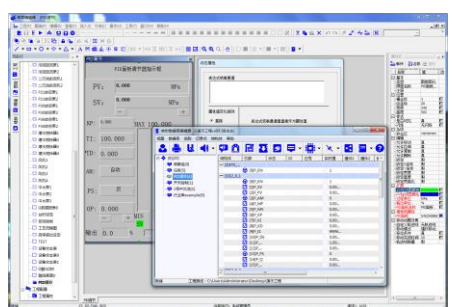
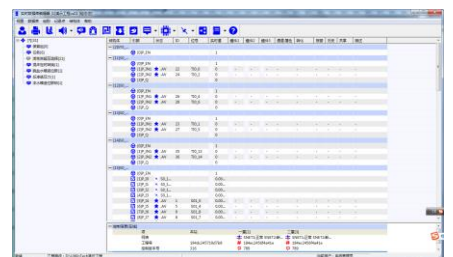
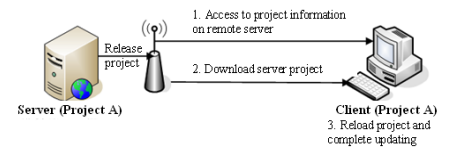

5.2 Software Functional Modules

- Project Management Configuration is achieved through Project Manager UWinWKS, which manages all the current control projects in the LAN or WAN. UWinWKS possesses a variety of functions, featuring: build, add, modify, delete, search, backup, etc. Moreover, it is able to enter kinds of functional software modules and modify RDB, control strategies, HMI and user security information, etc.
- UWinCFG realizes configuration of I/O Modules and Controller Modules, real-time supervision of all Modules/Sub-modules, on-processing downloading of projects, fault-diagnosis of Module/Sub-module and configuration and so on.
- Able to browse hardware resource of control system, diagnose information of CNet and SNet, configure Modules/Sub-modules I/O signal type as well as parameters information. Furthermore, UWinCFG possesses powerful hardware-fault-diagnosis capability – diagnostic information to channel-level, helping the user to spot abnormal channels in time.
- UWinRDB is used to define Tags information of each station, including the station's component instrumentations and attributions, each Tag's attributions such as data acquisition & conversion, alarm, history recording, security zone, etc; Realizes globally consistent & unified interface.
- History Database Software UWinHDB sets recording modes & parameters, provides efficient history data inquiry interface, supports on-line adding/deleting recording Tags, high-efficient data compressing and flexible accessing;
- Devices Management Software UWinDev realizes configuration & management of external devices;
- UWinMaker Graphical Develop System allows drawing & editing of process graphics such as Overview Map, Flowchart and Working Diagram of the system.
- Graphical Supervision System UWinView realizes dynamic display, operation management, and accomplishes supervision functions including alarm, history recordings and tendency curves through real-time data communication.
- Alarm Setting Software UWinAlarm fulfills different alarm requirements by setting attributions like alarm groups, alarm sound effects, alarm limits, alarm bias, changing rate alarm, etc.
- Algorithm Builder (UWinIEC) is used to generate control strategies of all continuous control, logic control, sequential control, specialized process algorithm, etc; Supports IEC61131-3 International standardized FBD, LD, SFC, ST and IL programming language for process control as well as their mixed programming, supports off-line/on-line debugging and simulation.
- Sequence of Events Analysis Software UWinSOE provides retrieving & tracing of sequence of events responds; Resolution time 1ms.
- WEB Server UWinWEB provides internet & IE based Browser Remote Visiting, thus realizes supervision that is highly consistent with local system.

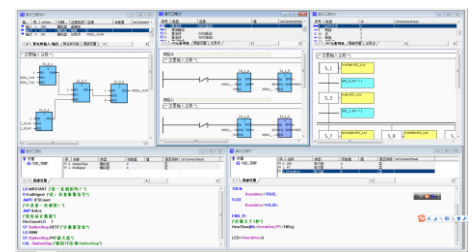
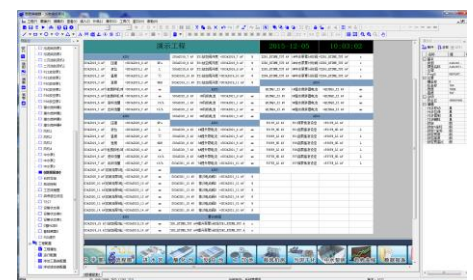
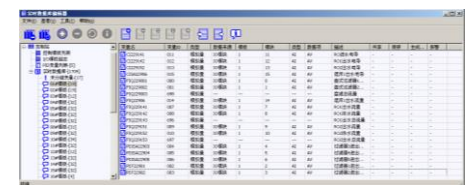
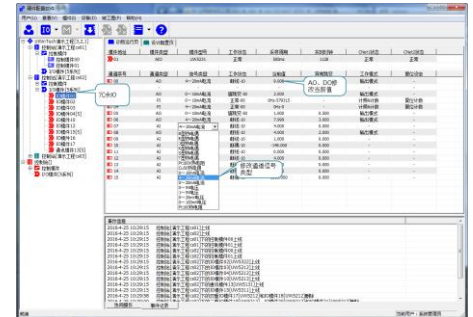
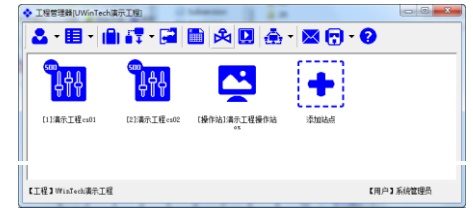

5.3 System Engineering Flowchart

UWinTech Control Engineering Application Software Platform provides integrated development environment for control project engineering., in which: Hardware Configurator realizes design & management of system hardware resources; Real-time Database & History Database Programming build up real-time database of engineering project; Graphical Development & Supervision System sets up Human-Machine Interfaces such as process display and interactive operation for the project; Algorithm Builder accomplishes control strategies of the project; Functional Modules generate related hardware configuration, real-time database, history database, process supervision, control arithmetic programming and kinds of report objects files ---- all of which are then downloaded to each Control Station or Operator Station, work together to accomplish system engineering design functions of the project.

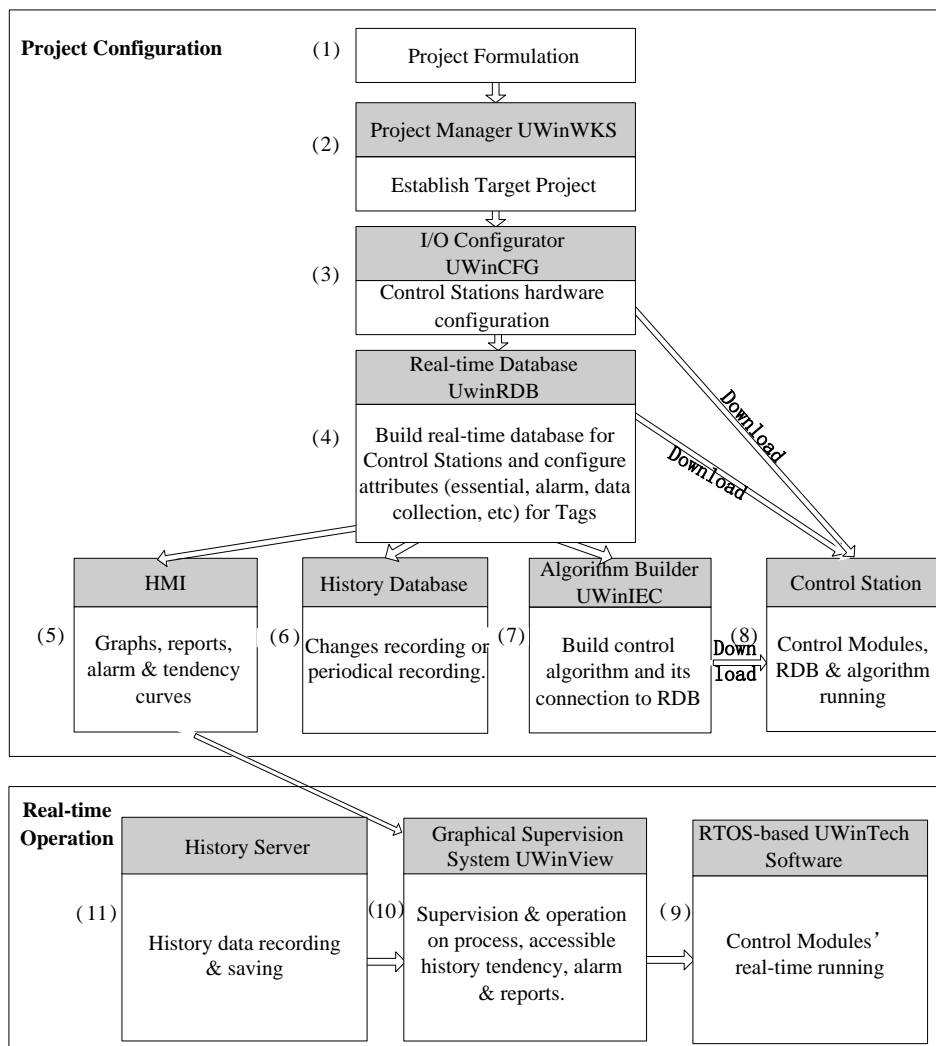

System Engineering Flowchart of UWinTech Control Engineering Application Software Platform

Step (3)、(4)、(5)、(6)、(7) of the flowchart above can be done synchronously in configuration, no specially defined sequence. For projects which have multiple Control Stations, each station's database, algorithms and process diagram might be individually programmed by different people, and then combine them into an entire engineering system by using the import/export function provided by the configurator software.

5.3.1 Establish Project

Establishing New Project: click on “工程/Project” menu, then select “新建/New (N)”, open “浏览文件夹/Browse Folders” dialog, click on “确定/OK” button and then type in project name & commentary in the popped up “新建工程/New Project” dialog, click on “确定/OK” to complete establishing the new project. After that, set up stations information: select “站点/Stations” menu, select “添加/Add”, then type in stations name, SNet base address, redundancy mode, commentary, etc. in the opened new stations window. Click on “确定/OK” to complete adding stations.

Opening Existed Project: click on “工程/Project” menu, then select “打开/Open (O)”, click on “是/Yes (Y)” button on the popped up “是否关闭当前工程?/Close present project?” dialog to close the present project. Then find the desired project in “浏览文件夹/Browse Folders” dialog, select the project and click on “确定/OK”, then the project opens after user logs in.

Start-up Default Setting: user may define the project to be opened and the account to log in, as well as functional software modules to be opened.

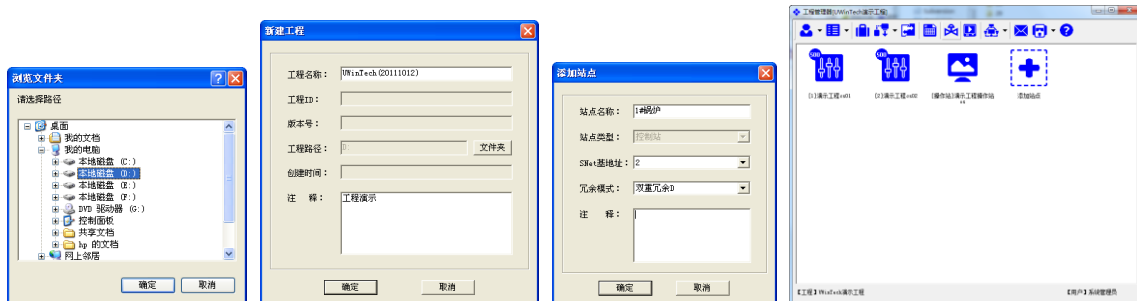

5.3.2 Hardware Configuration

Control Program Download or Update: Select a Controller Module, double click “高级操作/Advanced Operation” in the information list on the right side, select local control program in the opened dialog, click on “开始下载/Begin Downloading” button. Wait until the progress bar is full, quit this window, double click “重启/Restart” in the Controller Module information list to finish downloading control program of the Controller Module.

Configure I/O Modules: Open I/O Modules list, select I/O Module; or right click and select “Add I/O Module” in the popped up menu, then input I/O Module information in corresponding dialogs, like Initial Address, Redundancy Mode, Module Type, etc.

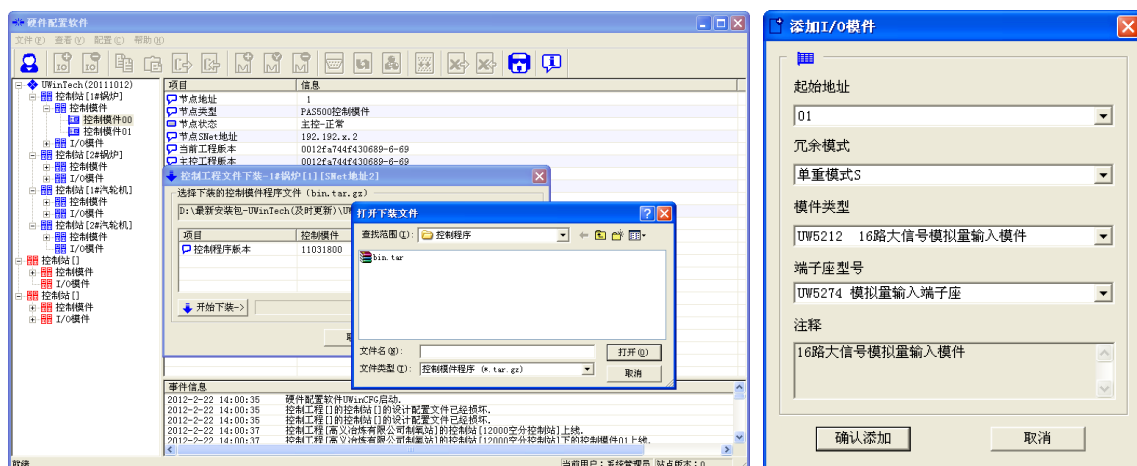

5.3.3 Data Generation

Database Groups: The user may build up database groups, and then set up recording tags in different groups;

Recording Tags might be added individually or in batch.

Add Single Tag: Select “记录点/Recording Tags” in the menu, select “添加/Select”, after an add recording dialog pops up, input position number, data type, industrial unit, security zones, etc; After input all information, click “确定/OK” button to finish adding this single tag.

Add Multiple Tags: Select “记录点/Recording Tags” in the menu, select “添加/Select”, after a “添加记录/Add Recording” dialog pops up, input prefix, initial number, end number, number of digits, etc; After input all information, click “确定/OK” button to finish adding multiple tags.

User may define tag information when adding or editing recording tags; In link information, tick the device link, and then select corresponding redundancy mode, device type, modules and channels; In alarm information, tick alarm enable, and then set alarm sound-effects-family, alarm groups, different alarm limits & levels; Recording tags data supports import/export in special format or Excel format.

Struct of Recording Tags: User may define and construct the discrete recording tags into combinations, according to control project or engineering objects' mechanism;

Database Downloading: In the toolbar, select “下装数据库/Download Database”, after an “文件下装/Download Files” dialog pops up, select the Controller Module which needs to download on, click “下装&重载/Download & Reload” button. When the progress bar is full, and project number is matched with the present project, it means that real-time database is successfully downloaded; Real-time Database supports on-process downloading.



5.3.4 History Recording

When opening History Database, there will first pops up “历史数据库配置/History Database Programming” dialog for selecting the storing path of history data; In the opened menu, select “添加记录方式/Add Recording Mode”, after a dialog for adding recording mode pops up, input time in “记录方式/秒 / Recording Mode/sec” column, click “确定/OK” then successfully added recording mode; Select the new history recording, right click to open menu and select “添加组别/Add Group”, after a dialog for adding recording groups, input group name, click “确定/OK” then successfully added a recording group; Select the new recording group, right click to open menu and select “添加记录点/Add Recording Tags”, after a dialog for selecting history recording tags pops up, tick the blocks before the tags, click “确定/OK” then successfully added recording tags; Click “启动历史服务/Start History Service” button in the toolbar, click “确定/OK” and then the history service function is starts running.



5.3.5 Graphics & Supervision Programming

In Human-Machine Interface (HMI) builder, the user can use the graphical elements and graphs library, combined with the actual technical process, to build process supervision pictures, and afterwards, run the already built pictures in the graphical supervision system.

In the graphics maker, click “画面/Picture (P)” in the menu, select “新建画面/New Picture (N)”, then in the guidance column, a new process picture is made; To insert graphical elements into the new process picture, click “插入/Insert (I)” button in the menu, select the wanted graphical element, and left click to draw the element onto the picture; The insertion of UWinTech specialized control element is the same as that of a graphical element; Double click the element, in the popped up attribution window the user may edit the basic attributions as well as dynamic links of the element; Moreover, the user may program events for graphical elements: right click on the element, select “事件定义/Define Events” in the popped up menu, after that a dialog for events definition would pop up, select events & action, and define input data source.

After a picture is built, click “保存/Save” button on the upper left corner of the toolbar to save picture; Then click on “打开运行系统/Open Operation System”, that is, graphical supervision system, to realize supervision & operation on the industrial process, as well as inquiry for history tendency, alarm information and report data.

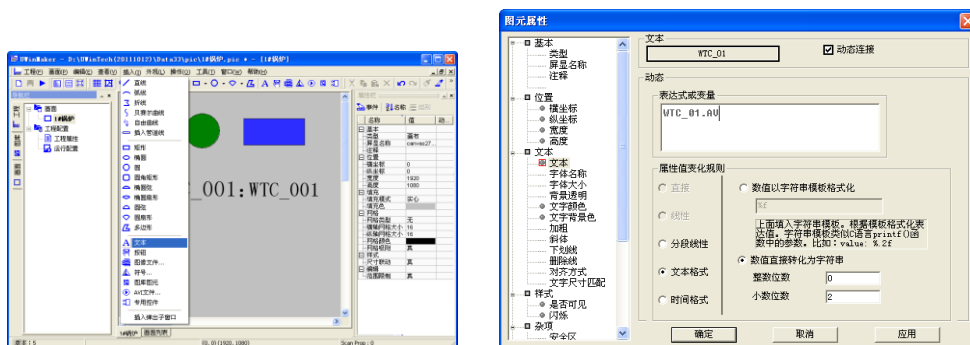

5.3.6 Control Arithmetic Programming

In the Control Algorithm Builder, the user can use the 5 provided language as well as subprograms for programming, and download them to Controller Modules for operation.

FBD programming language: Function Block Diagram, select FBD programming, click “程序/Program (P)” in the menu, select “新建程序/New Program” and then input the following attributions into popped up dialog: program name, program cycle time, commentary, etc. Click “确定/OK” then successfully established an FBD program. To build algorithm in the new FBD program, click “插入/Insert (I)” in the menu, then there pops up the Function Blocks selection window, for the user to select the wanted

FBs from basic algorithms pool, and insert into program. Select an FB, click “确定/OK”, then a transparent block will appear in the edit zone, left click to complete the insertion of this block; The I/O pins of an FB can be connected to recording tags, local variables, constants or connection lines.

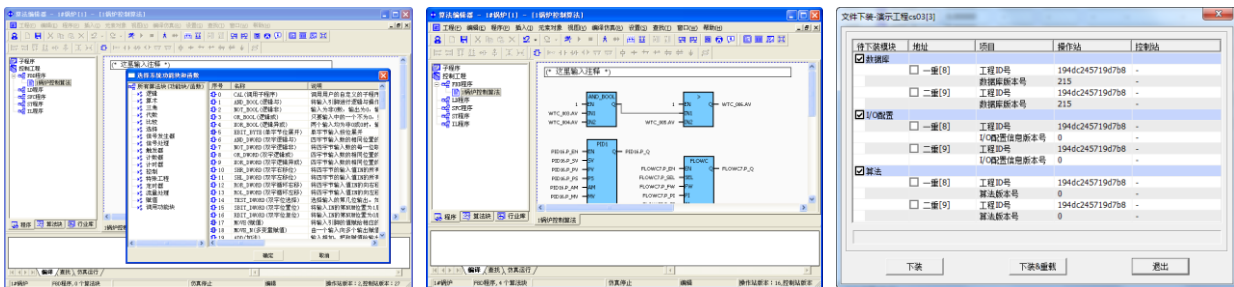

The user may either apply any of FBD, LD, SFC, ST, IL for programming, or mixed language, according to project's engineering requirements and engineer's programming habits.

Compile & Download: click “编译工程/Compile Project” button in the toolbar, then the information window will inform the user whether the compiling has succeeded, only after succeeded, the control algorithm program would be downloaded; Click “全部下载/Download All” button in the toolbar, after a dialog for algorithm program downloading pops up, click “下载&重载 / Download & Reload” button to begin downloading. When the progress bar is full, and project number matches with the present project, it means that the control algorithm program is downloaded successfully. Further more, the user may conduct on-process supervision and on-process programming on the algorithms, this is also achieved through the buttons in the toolbar.

Appendix 1: Main Technical Parameters & Environmental Requirements

1.System Accuracy	<ul style="list-style-type: none"> ● History Database: 100,000, 2,000G HDD
<ul style="list-style-type: none"> ● AI accuracy: $\pm 0.1\%$F.S 	<ul style="list-style-type: none"> ● Real-time Graphs: 512
<ul style="list-style-type: none"> ● AO accuracy: $\pm 0.1\%$F.S 	<ul style="list-style-type: none"> ● System Net: 96
<ul style="list-style-type: none"> ● SOE time resolution: 1ms 	<ul style="list-style-type: none"> ● Control Net: 64
2.System Anti-disturbance Capability	7.Signal Interface Characteristics
<ul style="list-style-type: none"> ● AI channel CMRR: $\geq 120\text{dB}$ 	<ul style="list-style-type: none"> ● AI input impedance: voltage $2\text{M}\Omega$; current 75Ω
<ul style="list-style-type: none"> ● AI channel DMRR: $\geq 60\text{dB}$ 	<ul style="list-style-type: none"> ● Type III AO load: 4-20mA, 750Ω
<ul style="list-style-type: none"> ● Isolation impedance: $20\text{M}\Omega @ 500\text{VDC}$ 	<ul style="list-style-type: none"> ● Type II AO load: 0-10mA, 1500Ω
3.Reliability	<ul style="list-style-type: none"> ● DI point: conduction resistance $< 1\text{K}\Omega$; open-loop resistance $> 35\text{K}\Omega$
<ul style="list-style-type: none"> ● Redundant Power Supply Module (optional) 	<ul style="list-style-type: none"> ● DO max load: 250VAC, 5A
<ul style="list-style-type: none"> ● Redundant Network (Standard) 	<ul style="list-style-type: none"> ● Over-voltage & over-current protection on all field wiring terminal
<ul style="list-style-type: none"> ● Redundant Controller Module (optional) 	8.System Margin (recommended)
<ul style="list-style-type: none"> ● Redundant I/O Module (optional) 	<ul style="list-style-type: none"> ● Operator Station: $< 30\%$
<ul style="list-style-type: none"> ● Supports Modules Removal/Insertion Under Power 	<ul style="list-style-type: none"> ● System Net: $< 30\%$
<ul style="list-style-type: none"> ● AO holding (system not power-off) 	<ul style="list-style-type: none"> ● Control Station: $< 60\%$
<ul style="list-style-type: none"> ● MTBF $\geq 200,000\text{h}$ 	<ul style="list-style-type: none"> ● Control Net: $< 50\%$
<ul style="list-style-type: none"> ● System Availability: $\geq 99.9995\%$ 	9.Power Supply
4.Real-time Characteristics	<ul style="list-style-type: none"> ● AC input voltage: 176V-264VAC, 47Hz-63Hz
<ul style="list-style-type: none"> ● Data scan cycle: Digital 50ms; Analog 100ms 	<ul style="list-style-type: none"> ● DC output power supply: voltage drop $< 0.8\%$ @ maximum load
<ul style="list-style-type: none"> ● Loop control cycle: 100ms 	<ul style="list-style-type: none"> ● Ripple coefficient: $< 5\%$
<ul style="list-style-type: none"> ● Logic control cycle: 50ms 	<ul style="list-style-type: none"> ● Over-current protection: load $> 110\text{-}150\%$ of rated
<ul style="list-style-type: none"> ● Real-time graph response time: $\leq 500\text{ms}$ 	<ul style="list-style-type: none"> ● Over-voltage protection: voltage $> 125\text{-}145\%$ of rated
5.Network Characteristics	10.System Working Environment
<ul style="list-style-type: none"> ● CNet Baud rate: 1MBPS 	<ul style="list-style-type: none"> ● Working temperature: $-20\sim 60^\circ\text{C}$
<ul style="list-style-type: none"> ● SNet Baud rate: 10M/100MBPS 	<ul style="list-style-type: none"> ● Storage/transportation temperature: $-40\sim 70^\circ\text{C}$
6.Maximum Capacity	<ul style="list-style-type: none"> ● Working humidity: 10~85%RH
<ul style="list-style-type: none"> ● Real-time Database: 100,000 	<ul style="list-style-type: none"> ● Storage/transportation humidity: $\leq 93\%$RH(40°C)
<ul style="list-style-type: none"> ● Control Station: AIO:512 or DI:1024 or DO:512 per station 	<ul style="list-style-type: none"> ● Atmospheric pressure: 86~106kPa

Appendix 2: Modules Size, Modules Address Setting & Installation in Cabinet

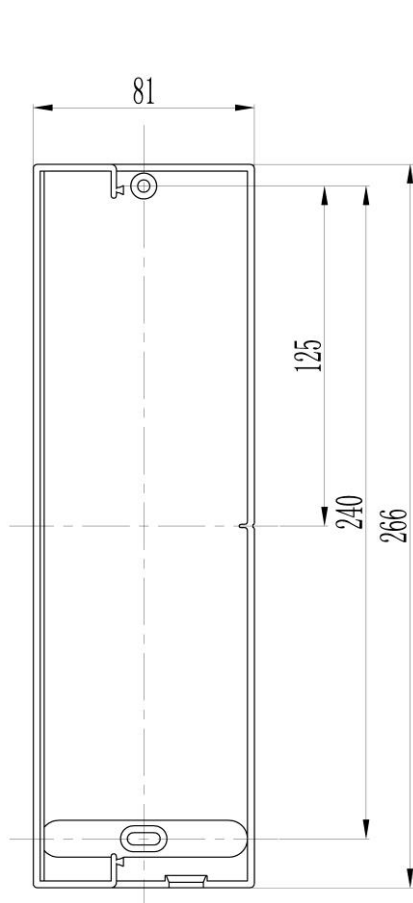

Terminal Chassis for Single Modules
Installation Dimension Drawing

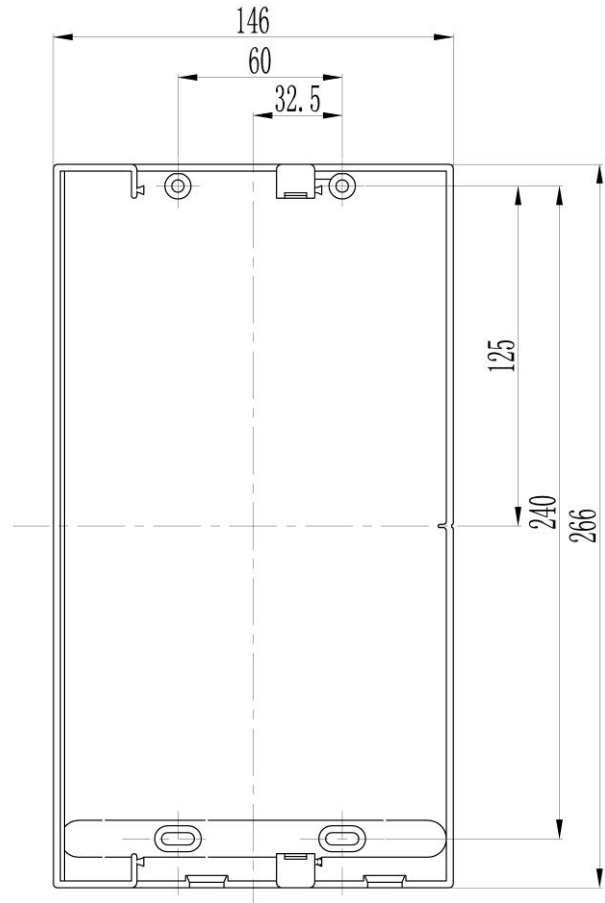

Terminal Chassis for Modules with Redundancy
Installation Dimension Drawing

Module IP Setting						S6-S7	Module Address
S0	S1	S2	S3	S4	S5		
0	0	0	0	0	0	reserved	0
1	0	0	0	0	0		1
0	1	0	0	0	0		2
1	1	0	0	0	0		3
0	0	1	0	0	0		4
1	0	1	0	0	0		5
0	1	1	0	0	0		6
1	1	1	0	0	0		7
0	0	0	1	0	0		8
1	0	0	1	0	0		9
0	1	0	1	0	0		10
1	1	0	1	0	0		11
0	0	1	1	0	0		12
...
1	0	1	1	1	0		29
0	1	1	1	1	0		30
1	1	1	1	1	0	31	

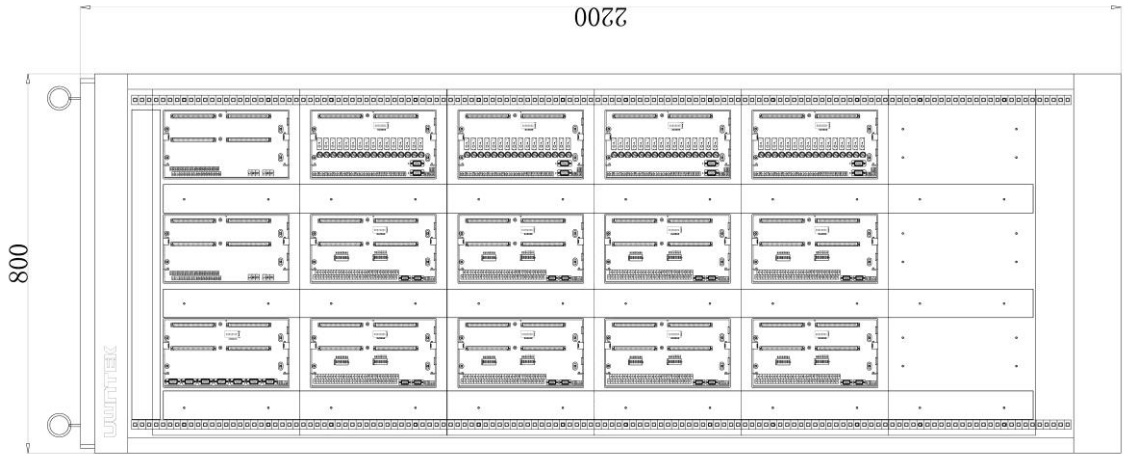

Cabinet Rear diagram (could be installed with I/Os)

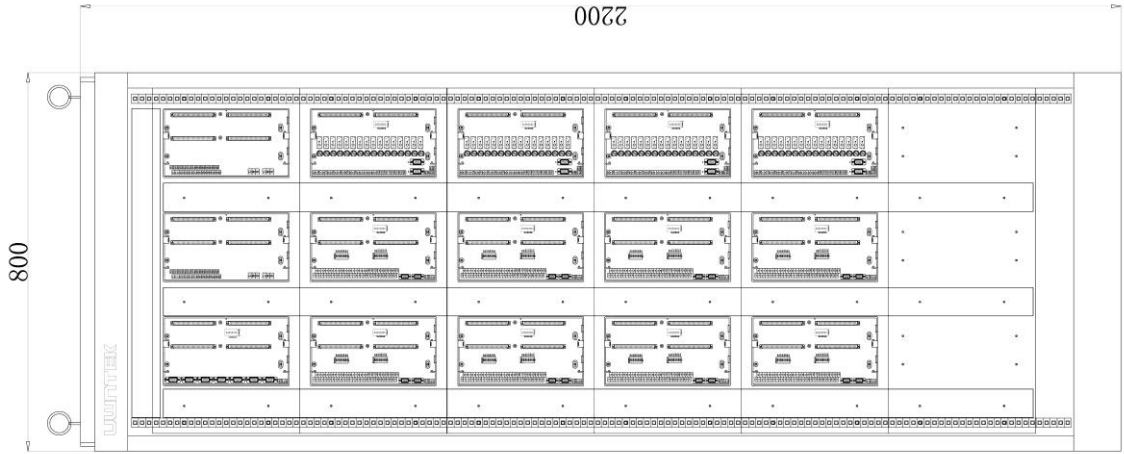

Cabinet configuration with redundant Controller, redundant Power Supply, redundant I/Os

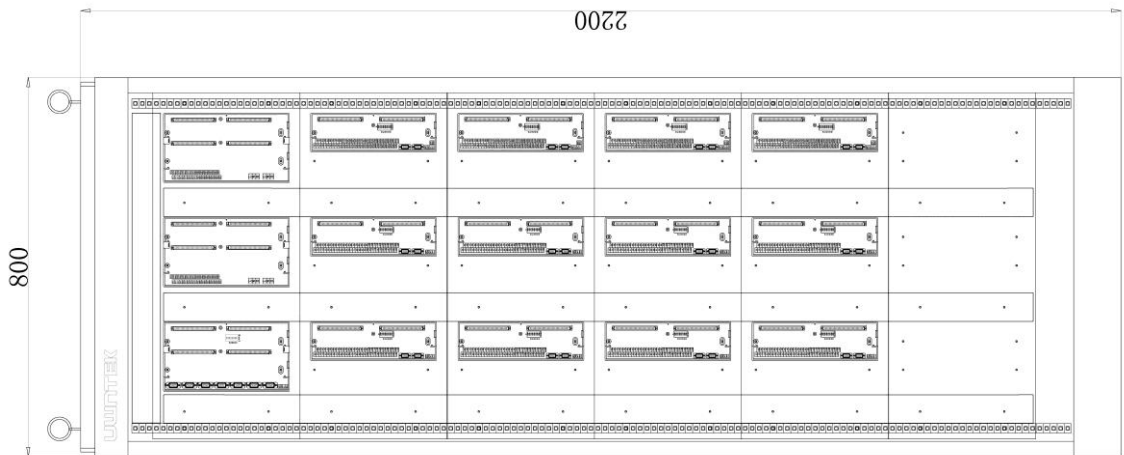

Cabinet configuration with redundant Controller, redundant Power Supply, non-redundant I/Os

Appendix 3: UW500 DCS Form Selection Guidance

Type	Product	Product Description
Functional Modules in Control Station	UW5101	Controller Module
	UW5102	Controller Module (high performance)
	UW5131	Modbus Communication Module
	UW5132	Remote I/O Communication Module
	UW5172	specialized Terminal Chassis for Controller Modules with Dual-Redundancy.
	UW5174	Specialized Terminal Chassis for Modbus Communication Modules.
	UW5175	Specialized Terminal Chassis for Remote I/O Communication Modules
	UW5211	16 Channels HART Analog Input Module
	UW5212	16 Channels Large-Signal Analog Input Module
	UW5213	16 Channels TC Analog Input Module
	UW5214	16 Channels RTD Analog Input Module
	UW5231	16 Channels Mixed Analog Input/Output Module
	UW5261	Universal Analog Input Sub-module
	UW5264	Pulses Input Sub-module
	UW5266	Analog Output Sub-module
	UW5271	Terminal Chassis for Analog Input/Output
	UW5272	Specialized Terminal Chassis for Analog Input with Dual-Redundancy
	UW5274	Terminal Chassis for Analog Input (for UW5212)
	UW5275	Specialized Terminal Chassis for Analog Input with Dual-Redundancy (for UW5212)
	UW5277	Specialized Terminal Chassis for Analog Output with Dual-Redundancy
	UW5311	32 Channels Digital Input Module
	UW5322	16 Channels Digital Output Module
	UW5341	32 Channels SOE Recorder Module
	UW5371	Terminal Chassis for Digital Input
	UW5372	Specialized Terminal Chassis for Digital Input with Dual-Redundancy
	UW5374	Terminal Chassis for Digital Level-Input
	UW5375	Terminal Chassis for Digital Switch-Input (for UW5341)
	UW5381	Terminal Chassis for Relay Output (16-channel relay, for UW5322)
	UW5382	Terminal Chassis for Digital Output with Dual-Redundancy
	UW5385	Terminal Chassis for Relay Level-Output (16-channel relay, for UW5322)
	UW5411	System Power Supply Module
	UW5472	Specialized Terminal Chassis for Power Supply Modules with Dual-Redundancy
	UW5481	Terminal Chassis for DC Single System Power Supply Modules
UW5482	Terminal Chassis for DC Single System Power Supply Modules with Dual-Redundancy	
UW5483	DC Power Distribution Economic Type Power Supply Modules with Dual-Redundancy	
UW5484	DC Power Distribution Economic Type Power Supply Modules	
Cabinet & Accessories	UW5141	Cnet Control Network Terminal Adapter Module
	UW5531	Modules Communication Cable (0.6m)
	UW5136	8*2 Channels Ethernet Exchanger Module with Redundancy
	UW5137	16*2 Channels Ethernet Exchanger Module with Redundancy
	UW5485	Dual Power Switch & AC Power Supply Module
	UW5541	Industrial Standard Cabinet (800mm*600mm*2200mm, 27")

	UW5542	Industrial Cabinet (760mm*300mm*1000mm)
	UW5561	Industrial Standard Operator Desk (700mm*1118mm*750mm)
	UW5565	Professional Industrial Keyboard
Software & Documentations	UW5611	UWinTech Control Engineering Application Software Platform V3.0(1,000 tags)
	UW5612	UWinTech Control Engineering Application Software Platform V3.0(10,000 tags)
	UW5613	UWinTech Control Engineering Application Software Platform V3.0(infinite tags)
	UW5631	User Manual

The Selection of UW500 Control System

1. The Product Nomenclature of UW Control System

UW	5	X	XX
UWNTEK	500 Series	The No.1 in the name of The Control/Info Communication Series The No.2 in the name of The Analogue IO Series The No.3 in the name of The Digital IO Series The No.4 in the name of The Power Supply Series The No.5 in the name of The Industrial Standard Cabinet Series The No.6 in the name of The Software Series	Product Code

2. The Selection Of IO Mould&Terminal Chassis according to the IO Quantity.

Series	Signal series	The Selection of Mould Types	Configuration Instructions	The types of Match Terminal Chassis
AI	4-20mA	UW5211 16-Channels HART Analogue Input Module	Single Configuration	UW5274 Terminal Chassis for Analog Input(For UW5212
			Redundant Configuration	UW5275 Dual Redundant Terminal Chassis for Analog Input
	4-20mA 0~5V	UW5212 16-Channels L-Signal Analogue Input Module	Single Configuration	UW5274 Terminal Chassis for Analog Input(For UW5212
			Redundant Configuration	UW5275 Dual Redundant Terminal Chassis for Analog Input
	TC	UW5213 16-Channels TC Analogue Input Module	Single Configuration	UW5271 Terminal Chassis for Analog Input/output
			Redundant Configuration	UW5272 Specialized Terminal Chassis for Analog Input with Dual-Redundancy
	RTD	UW5214 16-Channels RTD Analogue Input Module	Single Configuration	UW5271 Terminal Chassis for Analog Input/output
			Redundant Configuration	UW5271*2 Terminal Chassis for Analog Input/output
	Universal	UW5231 16-Channels Mix Analogue Input/output Module+16-Channels Analogue Input Sub-module(UW5261)	Single Configuration	UW5271 Terminal Chassis for Analog Input/output
			Redundant Configuration	UW5272 Terminal Chassis for Analog Input with Dual-Redundancy
	Pulses	UW5231 16-Channels Mix Analogue Input/output Module+16-Channels Pulses Input Sub-module(UW5264)	Single Configuration	UW5271 Terminal Chassis for Analog Input/output
			Redundant Configuration	UW5272 Terminal Chassis for Analog Input with Dual-Redundancy
AO	4-20mA 0~20mA	UW5231 16-Channels Mix Analogue	Single Configuration	UW5271 Terminal Chassis for Analog Input/output
			Redundant	UW5271 Terminal Chassis for Analog Input/output

		Input/output Module+16-Channels Analogue Output Sub-module(UW5266)	Configuration	UW5277 Dual-Redundant Terminal Chassis for Analog Output
DI	Dry Contact	UW5311 32-Channels Digital Input Module	Single Configuration	UW5371 Terminal Chassis for Digital Input
			Redundant Configuration	UW5372 Terminal Chassis for Digital Input with Dual-Redundant
	24VDC		Single Configuration	UW5374 Terminal Chassis for Digital Level-Input
	220VAC		Redundant Configuration	UW5376 Terminal Chassis for 16 Channel Relay isolate Input
DO	Output	UW5322 16-Channels Digital Output Module	Single Configuration	UW5381 Terminal Chassis for Relay Output
			Redundant Configuration	UW5382 Terminal Chassis for Digital Output with Dual Redundant
	Output with Electric		Single Configuration	UW5385 Terminal Chassis for Relay Level-Output

Remarks:

- 1) UW5231 16-Channels Mixed Analog Input/output Module supports a mixed configuration of the Sub-Module UW5261, UW5266, UW5264;
- 2) The Calculation Method of the number of Modules& Terminal Chassis;
The Numbers of the Module=The Numbers of IO divided by the Number of Channels, to add 1 if not divisible);
The Single Configuration, the proportion of the Module and Terminal Chassis is 1:1;
The Redundant Configuration, the proportion of the Module and Terminal Chassis is the 2:1;

3. The Selection of Controller Module/Modbus Communications Module/System Power Supply Module.

The Module Name	Configuration	The Name of the Terminal Chassis
UW5101 Controller Module	Redundant Configuration	UW5172 The Terminal Chassis for Controller Module with Dual Redundant
UW5131 Modbus Communication Module	Single Configuration	UW5174 The Terminal Chassis for Modbus Communication Module
UW5132 Remote I/O Communication Modules.	Configured in Paris	UW5175 Specialized Terminal Chassis for Remote I/O Communication Modules.
UW5411 System Power Module	Redundant Configuration	UW5472 The Terminal Chassis for System Power Module with Dual Redundant

Remarks:

- 1) UW5101 Configuration: All the Controller Modules configured with dual-redundancy and can load 32 I/O Modules with maximum;
- 2) The load capacity of UW5131 Module Communication Interface is 32 nodes in Maximum. The Control Station can be configured within a Max of four UW5131 Modules;
- 3) UW5132 must be in pairs configured and the distance between two stations which are connected via Fiber, can not exceed 2 km.

- 4) The Configuration of UW5411: The Power of UW5411 is 168W. With Redundant configuration the total Power can be calculated following the Module list below. As usual, you may consider 10% Power Redundancy;
- 5) The UW5411 System Power Module is only applied as the System Power for Control Module Modbus Communication Module and IO modules. The External Power will be Additional Configured.

The Power of Modules blocks List

Module	System Power(W)	The Power for Other Equipment (W)
UW5101 Controller Module	2.5	No need of Extra Power
UW5131 Modbus Communication Module	2.5	
UW5132 Remote I/O Communication Module	2.5	
UW5211 16-Channels HART Analogue Input Module	1.5	12
UW5212 16-Channels L-Signal Analogue Input Module	1.5	12
UW5213 16-Channels TC Analogue Input Module	1.5	No need of Extra Power
UW5214 16-Channels RTD Analogue Input Module	1.5	
UW5231 16-Channels Mix Analogue Input/output Module	16	No need of Extra Power
UW5311 32-Channels Digital Input Module	1	8
UW5322 16-Channels Digital Output Module	1	16

4. The configuration of industrial cabinet and accessory

1) **UW5483 Economic-Direct Power with Dual-Redundant Power Unit.**

The UW5483: Rated Power is 150W. Provides 16-Channels power output, and each channel contains 1A changeable fuse. You may calculate the power and the number of UW5483 needed base on the module block list above.

2) **UW5136 2*8Channels Redundant Ethernet Switch Units / UW5137 2*16Channels Redundant Ethernet Switch Units**

Number of switches = number of Control module*2 + number of Operating Station.

3) **UW5541 Industrial Standard Cabinet (800mm*600mm*2200mm, 27")**

1-2 base board can be installed on the cabinet and the cabinet supports installation of both front and reverse provides 36 installation unit. A reservation is recommended; To leave 3 mounted units located at the bottom of both base boards. To state differently, using 30 numbers of installation unit to configure 24-27 unit of IO module.

4) **UW5485 Dual power supply switching switch and alternating current distribution unit**

UW 5485: Used for 2 way alternating power supply input, alternating power supply in the cabinet and auto temperate control system in the cabinet. Number of UW5485 equals to the number of cabinet.

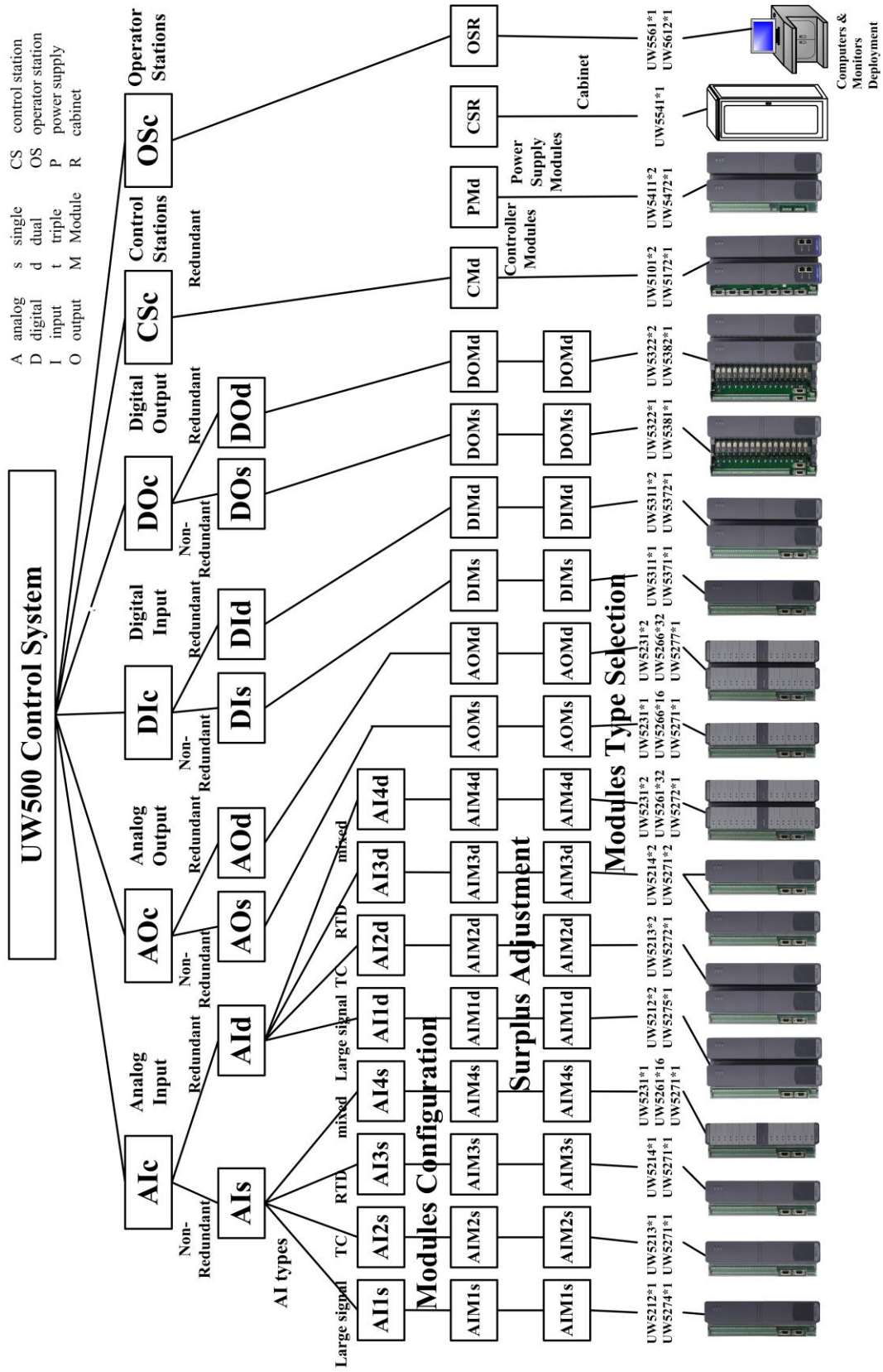

UW500 DCS Form Selection Flowchart

Chapter 6 Quality Control Management

Quality Target: Provide the most excellent & reliable control products, fulfill specialized needs of customers in all fields.

Fulfilling all kinds of requirements from the customers is always our final goal in developing new products. We investigate into customers' needs on all aspects including functional, technical and cost-effective, and we sincerely hope your direct participation. Our enterprise would gather professionals and talents together to discuss new ideas of products development.

We have synchronized design and test works: To ensure products quality, the Department of Testing would examine the entire project design since the beginning of product development. We conduct a series of strict & professional tests throughout the entire development procedure, and trial manufacturing can only be started after the design has passed all the tests.

Quality Commitment: Persist high-quality manufacturing, ensure the customer's satisfaction.

High-quality manufacturing: New developed products should pass through all quality examinations as well as comprehensive pre-manufacturing tests before manufacturing. While even more strict quality tests are to be conducted in manufacturing process.

Our resilient productivity guarantees commodities supply in-time. Our enterprise applies integrated purchasing & manufacturing system and reasonably allocates resources. We also improved manufacturing flexibility and efficiency, whatever are the users' demands large or small, we can always ensure supply in-time.

Total Quality Control: We apply Total Quality Control procedure in our manufacturing process. From part assembly to system integration, every product should go through examination individually, afterwards we further apply static / dynamic pre-firing tests.

Technical Support: Rich professional knowledge, provide specialized solutions for industry automation

Free technical support: The user may access to our technical support as well as latest technical news and products introduction in automation industry for free. Software updating service for free. Providing design solutions and remote technical supports for free.

Extraordinary OEM/ODM capacity: Equipped with long-time experience on Industrial Automation Design & Manufacturing, we are capable in fulfilling your specialized application demand, helping you to realize your distinctive design concepts. We can also work our and recommend you the most suitable solution for your application.

Prompt feedback to users' inquiries: If you have any technical problems reported to us, we promise reply within 24 hours.

Fast commodities supply: All types of products have reservation in storage, including all kinds of parts & accessories for system updating.



EMC/Immunity Development Devices

Key Projects Simulation Laboratory

Manufacturing & Completion Workshop

If contents in this manual is updated, please pardon us for not notifying you immediately



UWNTEK
打造优秀的控制系统产品



浙江大学工业自动化
国家工程研究中心

杭州优稳自动化系统有限公司
HANGZHOU UWNTEK AUTOMATION SYSTEM CO.,LTD.

Research & Development Center:
National Laboratory Building of Control Engineering,
Zhejiang University (310027)

Manufacturing Headquarter:
Add: Xi' hu Technology Park, Hangzhou Zhejiang province
Technical Support: 400-007-0089
Phone: 0571-88371966
Fax: 0571-88371967
Web: www.uwntek.com
E-mail: uwntek@uwntek.com